

THE NEW  
**AQUALISA**  
QUARTZ™ COLLECTION

SMART • CONNECTED • TOTAL CONTROL • INTERNET ENABLED  
SIMPLE • SMART • CONNECTED • PERSONAL PROGRAMMING • SHOWER AND BATHFILL APPLICATION • WATER USAGE MANAGEMENT • SMART • CONNECTED • SIMPLE







# INTRODUCING THE NEW QUARTZ™ COLLECTION

Founded on innovation leadership, Aqualisa has created a new range of next generation shower controls that establishes showering as an integral part of the smart home.



# SMART • CONNECTED • SIMPLE

---

The Quartz Collection shower range, from the leading name in smart shower technology, brings together the most sophisticated, yet accessible and user-friendly, choice of connected showers available in the market.

## QUARTZ TOUCH™

Even the most advanced smart control remains simple and intuitive with Quartz Touch, Aqualisa's most personal showering experience. A choice of pre-set shower programmes or individual shower and bath settings for the whole family, from anywhere, is modern showering personified.

See pages 6-9



## QUARTZ CLASSIC™

A proven best seller, Quartz Classic now takes its place at the heart of Aqualisa's smart shower range as a connected shower and bath control. Unsurprisingly, the Quartz Collection takes its inspiration from what is, quite simply, the UK's most trusted and recognised name for innovative showering technology.

See pages 10-13



## QUARTZ BLUE™

Quartz Blue is our new introduction to the enjoyment of smart showering. Discover the ease and convenience with all the internet enabled settings and controls, including a remote. New generation showering has just become a reality.

See pages 14-17



# PERSONALISE YOUR SHOWER SETTINGS & RELAX

---

With the busy lives we now lead, it is becoming increasingly important to find ways to step back, take a breath and relax. Smart showering technology in the bathroom not only offers flexibility and convenience, but also provides additional lifestyle benefits, from family safety to water saving, above and beyond traditional showering.

With pressure to reduce water consumption per person per day, smart products are a better way to manage water, improve efficiency and lower household bills. In particular, they can provide a solution for family homes and multi-generational requirements, with safety guaranteed and allowing the elderly or those with reduced mobility to remain independent.

The Quartz Collection is now fully connected with your home devices and controlled from the Aqualisa app or by simple voice activation. With the app, every member of the family can create and save a unique showering experience which is ready every time they take a shower. The app will also track water usage, running time and indicate the cost for eco-conscious households.

In a choice of modern and compact styles, the Quartz Collection looks good in the showering area while the intelligent Aqualisa SmartValve™ is located up to 10 metres away, making new and replacement installations easy to plan and fit.



QUARTZ™ BATH FILL





SIMPLE • SMART • CONNECTED • SIMPLE • SMART • CONNECTED • SIMPLE  
 PERSONAL PROGRAMMING • SHOWER AND BATHFILL APPLICATION • WATER USAGE MANAGEMENT  
 TOTAL CONTROL • SMART • CONNECTED • SMART • CONNECTED • SIMPLE  
 INTERNET ENABLED • SMART • CONNECTED • SIMPLE • SMART • CONNECTED • SIMPLE

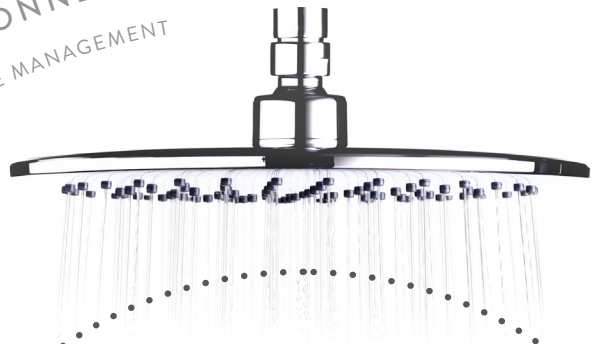

“Alexa,  
tell my shower  
to turn on”

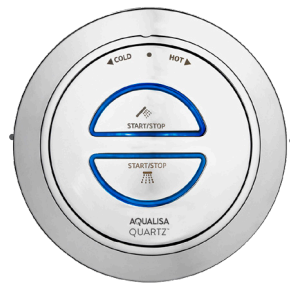









## QUARTZ TOUCH™

---

### Make it personal

Imagine your perfect shower. Always ready to step into when you are, and always at the exact temperature you like. Eco-friendly yes, but always sensational and invigorating. That shower is Quartz Touch, which delivers Aqualisa's most varied and personalised shower experience. From a selection of presets to your own personal shower profiles, this shower sets the gold standard for control, precision and consistency.





AQUALISA

38







## FLEXIBLE SHOWER CONTROL

---

Quartz Touch is available as a single or dual outlet option, with the choice of an adjustable handset featuring 4 spray patterns and an optional 230mm fixed drencher head. The shower can also divert to a programmed bath fill function. It's easy to install with all approved domestic water supplies and the app makes it incredibly simple to create and store your shower choices, all activated from your phone, a remote control on the wall or by using voice activation.









## QUARTZ CLASSIC™

---

A great shower has just got better

What more can be said about Quartz Classic? Lasting good looks, a pioneer of shower technology and a UK best seller. Now, it takes its rightful place in the smart bathroom as a WiFi connected shower control. You can expect the same level of performance from this market leading shower but with the added convenience of control from your smart device, a remote control on the wall or by a simple voice command.

## OUR FAVOURITE SHOWER HAS EVOLVED

---

Quartz Classic is available as a single or dual outlet option, with the choice of an adjustable handset featuring 4 spray patterns and an optional 230mm fixed drencher head. The shower can divert to a programmed bath fill function, but Quartz Classic is also available as a control for bath fill only. The familiar Quartz look and feel is set to continue at the forefront of showering excellence as part of the smart home revolution.















## QUARTZ BLUE™

---

### Step into smart showering

Are you ready for a new lifestyle? Quartz Blue is the ideal introduction to smart capability that will change the way you take a shower. With all its individual programme features and WiFi connectivity, the minimalist designer look of Quartz Blue conceals the level of intelligent technology built into this compact, but perfectly formed, shower control.







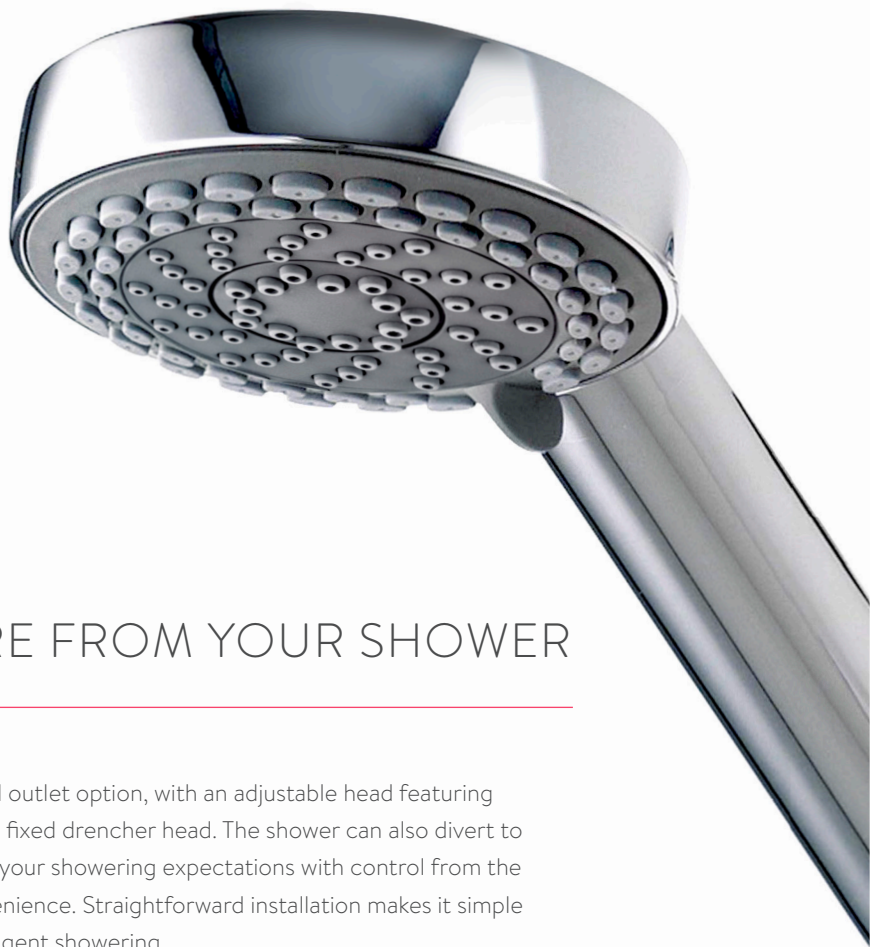

## EXPERIENCE MORE FROM YOUR SHOWER

---

Quartz Blue is available as a single or dual outlet option, with an adjustable head featuring 4 spray patterns and an optional 200mm fixed drencher head. The shower can also divert to a programmed bath fill function. Expand your showering expectations with control from the app or your voice for flexibility and convenience. Straightforward installation makes it simple to experience a new world of sheer, indulgent showering.









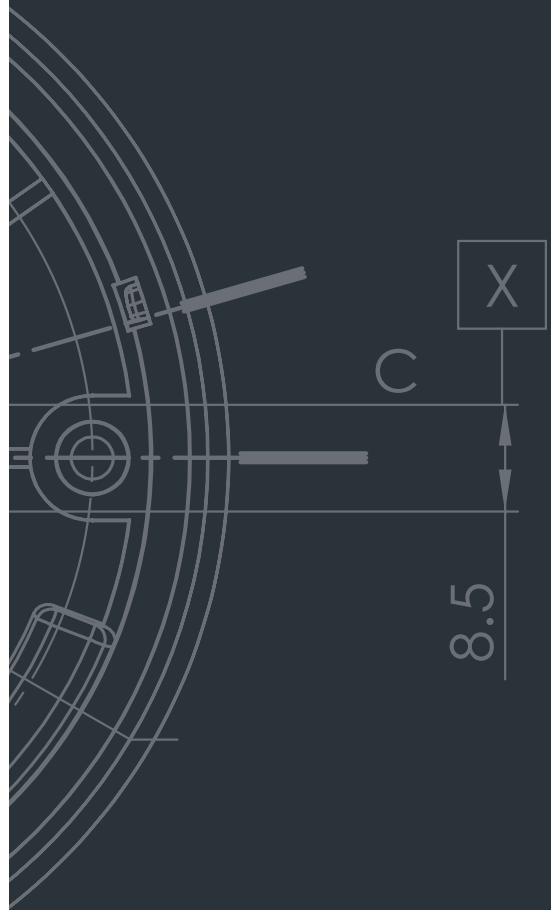

# THE QUARTZ™ COLLECTION

---

FEATURES AND DIMENSIONS



# QUARTZ TOUCH™ TECHNICAL SPECIFICATION



## Quartz Touch™ concealed with adjustable head

HP/Combi  
QZST.A1.BV.20  
Gravity Pumped\*  
QZST.A2.BV.20



## Quartz Touch™ concealed dual outlet with adjustable head and ceiling fixed drencher

HP/Combi  
QZST.A1.BV.DVFC.20  
Gravity Pumped\*  
QZST.A2.BV.DVFC.20



## Quartz Touch™ concealed dual outlet with adjustable head and bath overflow filler

HP/Combi  
QZST.A1.BV.DVBTX.20  
Gravity Pumped\*  
QZST.A2.BV.DVBTX.20



## Quartz Touch™ concealed dual outlet with adjustable head and wall fixed drencher

HP/Combi  
QZST.A1.BV.DVFW.20  
Gravity Pumped\*  
QZST.A2.BV.DVFW.20

## QUARTZ TOUCH™

### USER FEATURES

- One touch start and stop control
- Simple shower activation using the Aqualisa app, or voice command
- Wireless remote control
- Option to change flow to 'eco, medium or max'
- Select desired temperature
- Safe family showering with precise thermostatic temperature control and adjustable maximum temperature
- Eco mode setting saves up to 33% on your water consumption and unique proximity sensor reduces water flow when you step away from the shower
- Intuitive LED display for clear indication when your shower is ready to step into
- 105mm adjustable head, featuring 4 spray patterns and an optional 230mm fixed head or bath fill to customise your experience
- Up to 5 years parts and labour guarantee

### CONNECTED FEATURES (APP)

- Wifi, Mobile App & Amazon Alexa enabled for remote shower control
- 3 pre-set profiles for quick start use - Eco, Sport, Comfort - or create a unique showering experience with your personal choice of temperature, flow, outlet and running time, saved on the Aqualisa app
- Multiple showers can be operated from 1 app
- Timer feature allows you to set your shower duration
- Indicative usage dashboard tracks and records water usage, time and costs
- Safety feature which protects the shower users from others adjusting the shower remotely from the app

### INSTALLATION FEATURES

- Adjustable rail fixing points
- Exposed model for minimal disruption
- The Aqualisa SmartValve™ sited away from the showering area
- Push fit connections and isolation valves all included
- Suitable for all approved UK domestic water systems





**Quartz Touch™ concealed with wall fixed drencher**

HP/Combi  
QZST.A1.BR.20  
Gravity Pumped\*  
QZST.A2.BR.20



**Quartz Touch™ exposed with adjustable head**

HP/Combi  
QZST.A1.EV.20  
Gravity Pumped\*  
QZST.A2.EV.20



**Quartz Touch™ exposed dual outlet with adjustable head and ceiling fixed drencher**

HP/Combi  
QZST.A1.EV.DVFC.20  
Gravity Pumped\*  
QZST.A2.EV.DVFC.20



**Quartz Touch™ dual outlet exposed with adjustable head and bath overflow filler**

HP/Combi  
QZST.A1.EV.DVBTX.20  
Gravity Pumped\*  
QZST.A2.EV.DVBTX.20

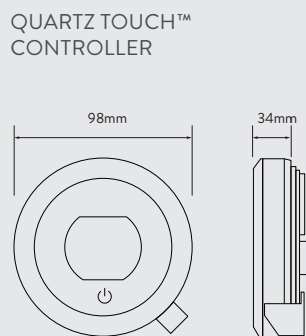
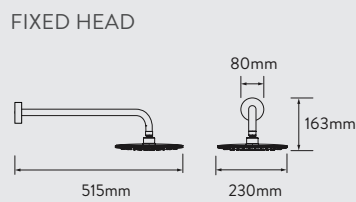
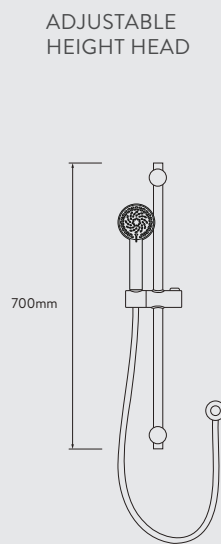
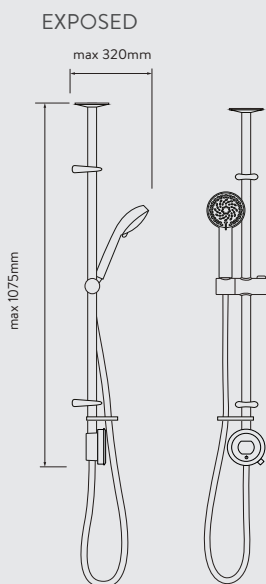

**QUARTZ TOUCH™ REMOTE CONTROL**



WR.BL.CP.20

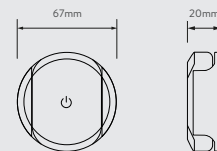

**BATH OVERFLOW FILLER**

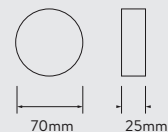



# QUARTZ CLASSIC™ TECHNICAL SPECIFICATION



## Quartz Classic™ with adjustable head

HP/Combi  
QZD.A1.BV.20  
Gravity Pumped\*  
QZD.A2.BV.20



## Quartz Classic™ dual outlet concealed with adjustable head and ceiling fixed drencher

HP/Combi  
QZD.A1.BV.DVFC.20  
Gravity Pumped\*  
QZD.A2.BV.DVFC.20



## Quartz Classic™ concealed with adjustable head and bath overflow filler

HP/Combi  
QZD.A1.BV.DVBTX.20  
Gravity Pumped\*  
QZD.A2.BV.DVBTX.20



## Quartz Classic™ concealed dual outlet with adjustable head and wall fixed drencher

HP/Combi  
QZD.A1.BV.DVFW.20  
Gravity Pumped\*  
QZD.A2.BV.DVFW.20

## QUARTZ CLASSIC™

### USER FEATURES

- One touch start and stop control
- Simple shower activation using the Aqualisa app, or voice command
- Remote control
- Safe family showering with precise thermostatic temperature control and adjustable maximum temperature
- Eco mode setting saves up to 33% on your water consumption
- Intuitive LED display for clear indication when your chosen temperature has been reached
- 105mm adjustable head, featuring 4 spray patterns and an optional 230mm fixed head or bath fill to customise your experience
- Easy to use button one touch start/stop control, divert optional
- Up to 5 years parts and labour guarantee

### CONNECTED FEATURES (APP)

- Wifi, Mobile App & Amazon Alexa enabled for remote shower control
- Multiple showers can be operated from 1 app
- Timer feature allows you to set your shower duration
- Indicative usage dashboard tracks and records water usage, time and costs
- Safety feature which protects the shower users from others adjusting the shower remotely from the app

### INSTALLATION FEATURES

- Adjustable rail fixing points
- Exposed model for minimal disruption
- The Aqualisa SmartValve™ sited away from the showering area
- Push fit connections and isolation valves all included
- Utilises the same Quartz data cable for a simple retrofit
- Suitable for all approved UK domestic water systems



\*Gravity Pumped variant comes with integral pump.



**Quartz Classic™ concealed with wall fixed drencher**

HP/Combi  
QZD.A1.BR.20  
Gravity Pumped\*  
QZD.A2.BR.20



**Quartz Classic™ exposed with adjustable head**

HP/Combi  
QZD.A1.EV.20  
Gravity Pumped\*  
QZD.A2.EV.20



**Quartz Classic™ dual outlet exposed with adjustable head and ceiling fixed drencher**

HP/Combi  
QZD.A1.EV.DVFC.20  
Gravity Pumped\*  
QZD.A2.EV.DVFC.20



**Quartz Classic™ exposed dual outlet with adjustable head and bath overflow filler**

HP/Combi  
QZD.A1.EV.DVBTX.20  
Gravity Pumped\*  
QZD.A2.EV.DVBTX.20

**QUARTZ™ EXPOSED**

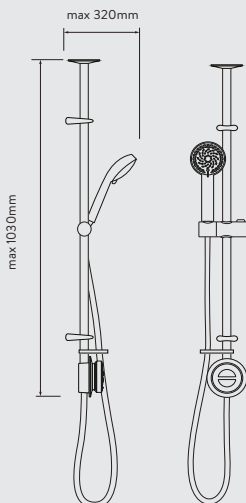

**ADJUSTABLE HEIGHT HEAD**

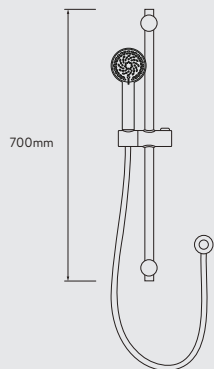

**FIXED HEAD**

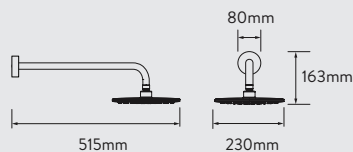

**QUARTZ CLASSIC™ CONTROLLER**

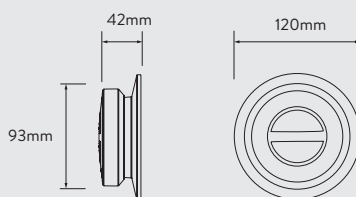

**QUARTZ CLASSIC™ REMOTE CONTROL**



QZD.B3.DS.20 (Single outlet)  
QZD.B3.DVDS.20 (Dual outlet)

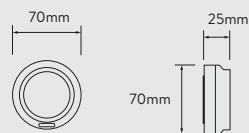

**BATH OVERFLOW FILLER**

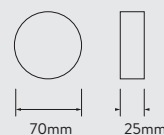



# QUARTZ BLUE™ TECHNICAL SPECIFICATION



**Quartz Blue™ concealed with adjustable head**  
 HP/Combi  
 QZSB.A1.BV.20  
 Gravity Pumped\*  
 QZSB.A2.BV.20



**Quartz Blue™ dual outlet concealed with adjustable head and wall fixed drencher**  
 HP/Combi  
 QZSB.A1.BV.DVFW.20  
 Gravity Pumped\*  
 QZSB.A2.BV.DVFW.20



**Quartz Blue™ dual outlet concealed with adjustable head and bath overflow filler**  
 HP/Combi  
 QZSB.A1.BV.DVBTX.20  
 Gravity Pumped\*  
 QZSB.A2.BV.DVBTX.20



**Quartz Blue™ concealed with wall fixed drencher**  
 HP/Combi  
 QZSB.A1.BR.20  
 Gravity Pumped\*  
 QZSB.A2.BR.20

## QUARTZ BLUE™

### USER FEATURES

- One touch start and stop control
- Simple shower activation using the Aqualisa app, or voice command
- Safe family showering with precise thermostatic temperature control and adjustable maximum temperature
- Eco mode setting saves up to 33% on your water consumption
- Intuitive LED display for clear indication when your shower is ready to step into
- 90mm adjustable head, featuring 4 spray patterns and an optional 200mm fixed head or bath fill to customise your experience
- Up to 5 years parts and labour guarantee

### CONNECTED FEATURES (APP)

- Wifi, Mobile App & Amazon Alexa enabled for remote shower control
- Multiple showers can be operated from 1 app
- Timer feature allows you to set your shower duration
- Indicative usage dashboard tracks and records water usage, time and costs
- Safety feature which protects the shower users from others adjusting the shower remotely from the app

### INSTALLATION FEATURES

- Adjustable rail fixing points
- Exposed model for minimal disruption
- The Aqualisa SmartValve™ sited away from the showering area
- Push fit connections and isolation valves all included
- Suitable for all approved UK domestic water systems





**Quartz Blue™ exposed with adjustable head**

HP/Combi  
 QZSB.A1.EV.20  
 Gravity Pumped\*  
 QZSB.A2.EV.20



**EXPOSED**

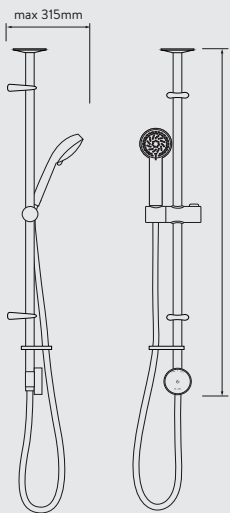

**ADJUSTABLE HEIGHT HEAD**

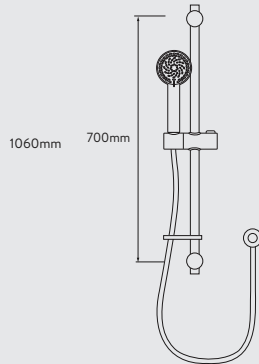

**FIXED HEAD**

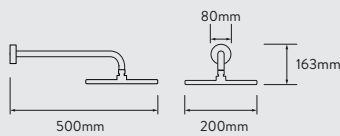

**QUARTZ BLUE™ CONTROLLER**

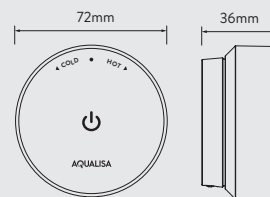

**BATH OVERFLOW FILLER**

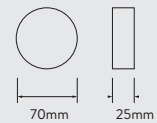



# QUARTZ™ COLLECTION

## AT A GLANCE FEATURES AND BENEFITS GUIDE



QUARTZ TOUCH™



QUARTZ CLASSIC™



QUARTZ BLUE™

FEATURES AND BENEFITS	QUARTZ TOUCH	QUARTZ CLASSIC	QUARTZ BLUE
Connectivity (wifi, app, Alexa)	•	•	•
Proximity sensor	•		
Online water management dashboard	•	•	•
Flow control	•	•	
Pre-set shower profiles	•		
Timer function in app	•	•	•
Bath fill divert option	•	•	•
Single bath fill product		•	
Temperature ready indicator	•	•	•
Aqualisa SmartValve™ eco-setting	•	•	•
Hard wired remote option		•	
Wireless remote option	•		
Full LED screen	•		
Thermostatic temperature control	•	•	•
4 spray pattern Harmony handset	•	•	•
Rub clean jets	•	•	•
Dual outlet divert options	•	•	•
All water systems	•	•	•
5 Year Guarantee*	•	•	•

\* Registered product only

# AQUALISA FREE GUARANTEE

---

We pride ourselves on quality workmanship, engineering innovation and excellent Customer Service. Our products are covered with a manufacturer's free 1 year guarantee which can be extended up to 5 years. Registering your shower ensures you are covered, giving you access to our dedicated UK Customer Care team and specialist engineers.

For more information, visit:

[aqualisa.co.uk/register-guarantee](https://aqualisa.co.uk/register-guarantee)

## SMART SHOWER PREMIUM SERVICE

Your shower is just as important to us as it is to you. Our expert UK Customer Care team is on hand to answer all your queries. We offer nationwide coverage with our team of Aqualisa trained and approved service engineers. They are experienced and qualified engineers who fulfil the Aqualisa Customer Care promise.

## AQUALISA APP

The Aqualisa app is packed full of useful features, help and advice on how to get the best out of your shower.

To find out more visit:

[aqualisa.co.uk/smartapp](https://aqualisa.co.uk/smartapp)





# AQUALISA

Aqualisa Products Limited  
The Flyers Way  
Westerham  
Kent TN16 1DE

Customer Service Helpline: 01959 560 010  
Switchboard: 01959 560 000  
Direct Account Support: 01959 560 020  
Brochure request line: 0800 652 3669

Email: [enquiries@aqualisa.co.uk](mailto:enquiries@aqualisa.co.uk)  
Website: [www.aqualisa.co.uk](http://www.aqualisa.co.uk)  
Live chat: [www.aqualisa.co.uk](http://www.aqualisa.co.uk)



The company reserves the right to alter, change or modify the product specifications without prior warning. Please refer to the installation guides for technical information. Registered Trademark Aqualisa Products Limited.

Copyright © Aqualisa 2020. All rights reserved. No part of this brochure may be reproduced whether by copying or storing in any medium, electronic or otherwise, without the express permission of Aqualisa subject to any contrary provision under the Copyright, Designs and Patents Act 1988. Any unauthorised reproduction of any part of this brochure may lead to a civil claim for damages or criminal prosecution.

