

Miller

FINE BATHROOM INTERIORS

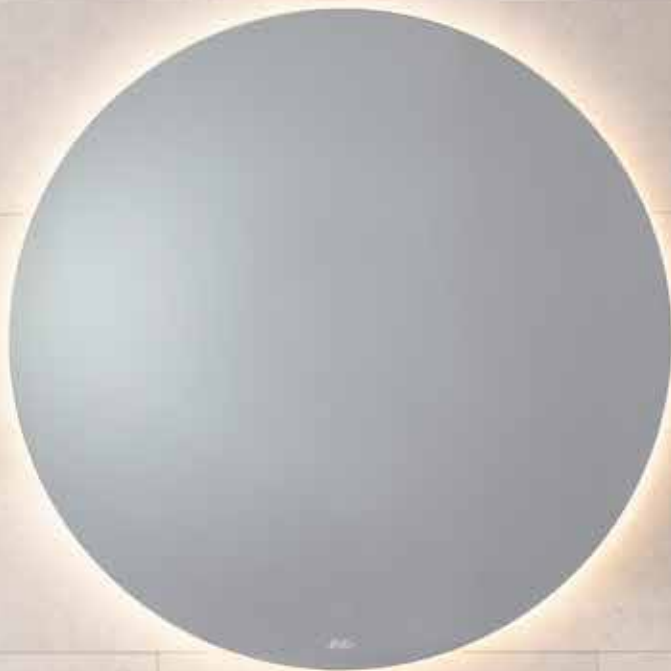

BATHROOM ACCESSORIES AND FURNITURE 2024

Your way. The Miller Way.

Given how much time your family spends in the bathroom you deserve something extra. As a timeless and beautiful design, just like your family, it becomes more beautiful with age.

Added care is given to the selected materials and finish, along with all the little details that make the products so beautiful. And not least, the choice that will give you the bathroom you really desire.

We believe that it is important your whole family enjoys dealing with us, as we ourselves are a family business that for five generations has delivered quality, authenticity and tradition.

We believe that your family deserves a good quality of life, even in the bathroom. We call it the Miller Way.



Bathroom Accessories **page 4**



Bathroom Furniture **page 68**



Tradition

In 1903, two brothers, Justus and Fritz Miller started casting furniture fittings in little Printzeryd in Sweden. They were skilled craftsmen who took great care with the fittings they supplied to make sure that they were of the highest quality. Today, over 100 years later, that same philosophy stands and with the business still under the Miller's ownership, and the family remains fully committed to the production of high quality, visually stunning products which stand the test of time.



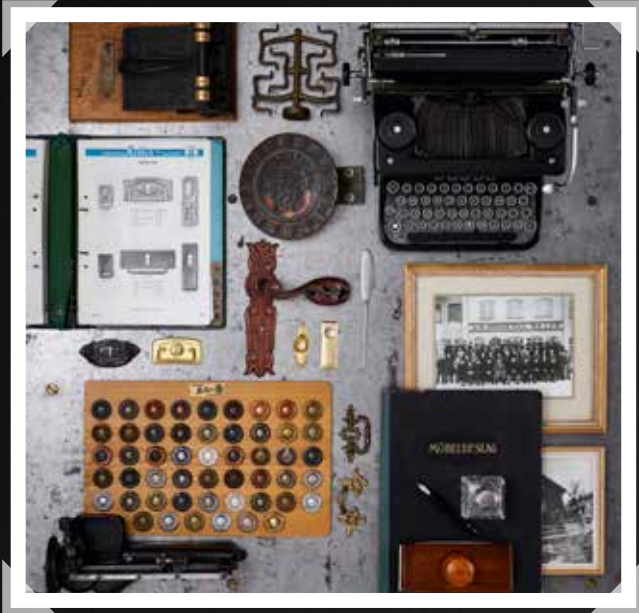

‘Beneath the surface there are all those little details that become more important over the years’

We know the surface is important in bathrooms. That’s the first thing your eyes see when you enter the room. A beautiful wall cabinet, the clean lines of a vanity unit, an elegantly shaped porcelain sink creates that special first impression. But it’s once you get to know your bathroom a little closer you will appreciate our attention to detail. Beneath the surface there are all those little details that become more important over the years.

We select wood with beautiful veining and finish with hard wearing, protective lacquer. We are careful to design drawers and doors which always open and close smoothly. We have thought about the extra storage that will be practical and functional. Everything we design is for a long lasting friendship. This is when the small details combine with the beautiful surfaces to give you a special bathroom – the Miller Way.

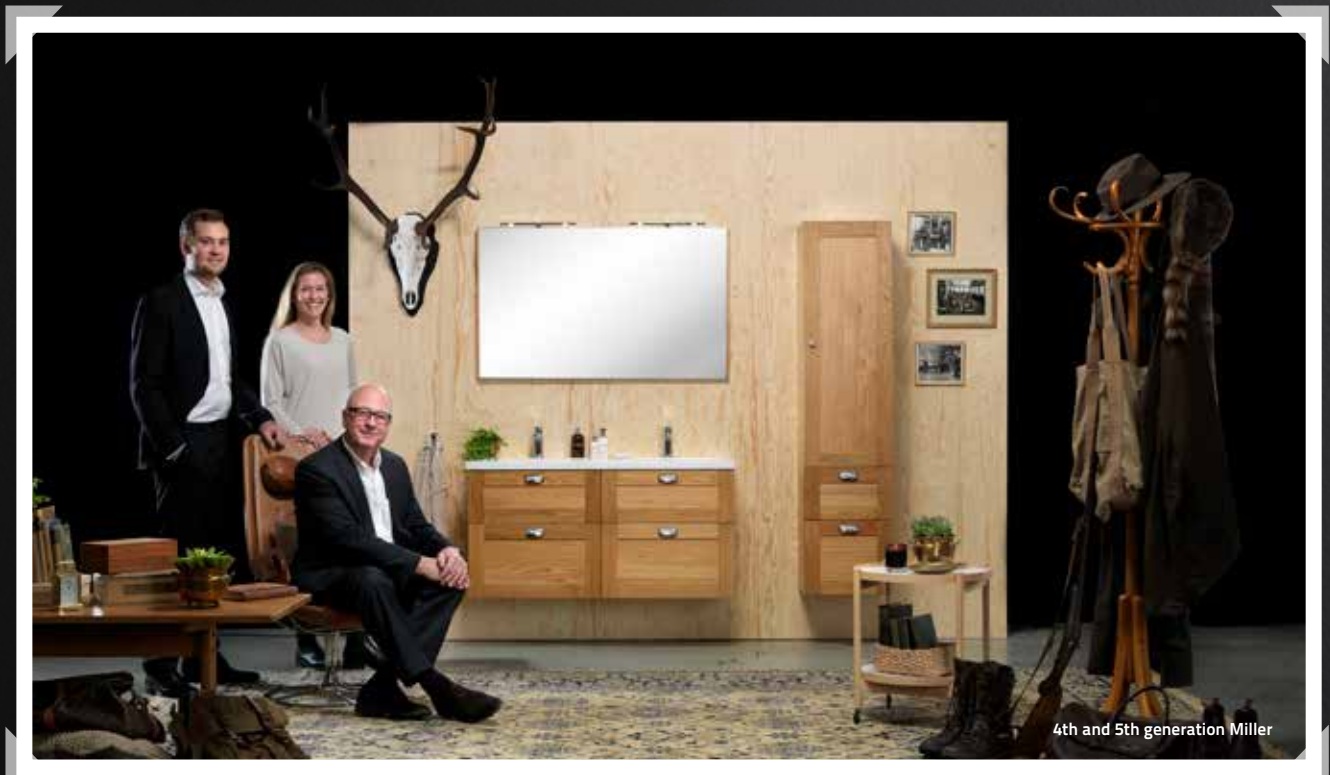

4th and 5th generation Miller

Bathroom Accessories

The perfect way to finish your bathroom is with the addition of one of Miller from Sweden's beautiful accessory collections. Thoughtfully designed to complement our furniture, there are many stylish and innovative solutions to choose from.



- | | | | |
|----|---------------------|----|-----------------------|
| 6 | What's New | 30 | Miami Stainless Steel |
| 8 | Atlanta Chrome | 32 | Montana |
| 10 | Atlanta Black | 34 | Orlando |
| 12 | Bond Chrome | 36 | Oslo Chrome |
| 14 | Bond Black | 38 | Oslo Nickel |
| 16 | Bond Brushed Brass | 40 | Richmond |
| 18 | Bond Polished Brass | 42 | Stockholm |
| 20 | Boston | 46 | Classic Accessories |
| 22 | Denver | 66 | Lily & Cube |
| 24 | Metro | | |
| 26 | Miami Chrome | | |
| 28 | Miami Black | | |



These accessories can also be fixed with our adhesive. All accessories are supplied with a wall screw pack. For "No drill" fixing purchase our fixing adhesive.





NEW!

What's New **6**



Atlanta Chrome **8**



Atlanta Black **10**



Bond Chrome **12**



Bond Black **14**



Bond Brushed Brass **16**



Bond Polished Brass **18**



Boston **20**



Denver **22**



Metro **24**



Miami Chrome **26**



Miami Black **28**



Miami Stainless Steel **30**



Montana **32**



Orlando **34**



Oslo Chrome **36** / Nickel **38**

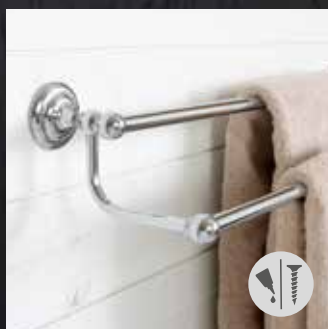

Richmond **40**



Stockholm **42**



Classic Accessories **46**



Lily and Cube **66**

Bond Diamond



NEW!

Bond, a Miller star, is now available in a new suit. **DIAMOND** cut, with its knurled surface, creates a distinct, exclusive, industrial feeling.

A simple backplate change, gives Bond a new look in your bathroom.



NEW!

Diamond style backplate is available as an option to Bond products in Chrome, Black and Brushed Brass finish.

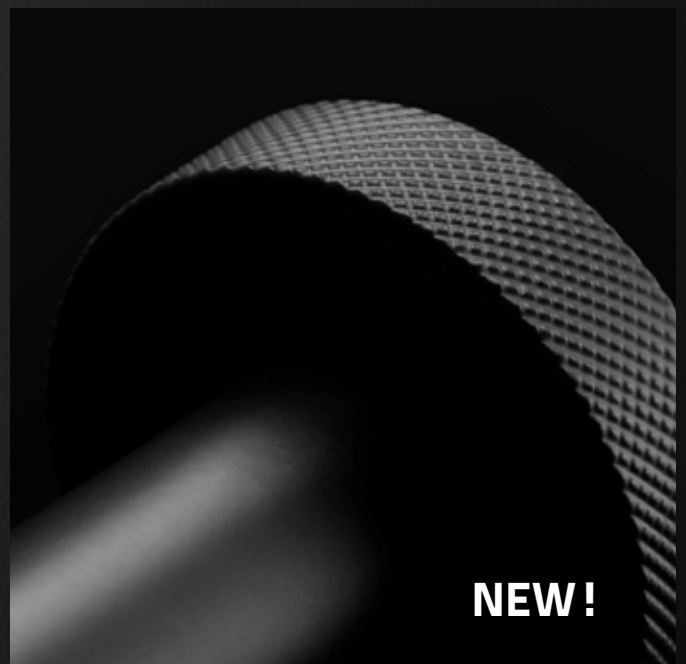

NEW!

Please see pages 12-17 for details or visit www.millerbathrooms.co.uk.

Stockholm now available in Polished Brass



Stockholm, our classic range of accessories, is now available in Polished Brass, allowing a

beautiful patina to be created over time. Please see pages 42-45 for details.



To complement the Stockholm Polished Brass products, we have introduced a popular selection of freestanding items. Please see page 50-51 for details.



ATLANTA

Atlanta's pure form and function provides a perfect balance of design and practicality. Benefiting from our full-fix system, this beautiful, chrome plated collection, provides everything you could wish for the finishing of your bathroom.



£48.75

TOILET ROLL HOLDER 8810C
W150 x H103 x D53 mm



£60

TOILET ROLL HOLDER with lid 8807C
W135 x H145 mm

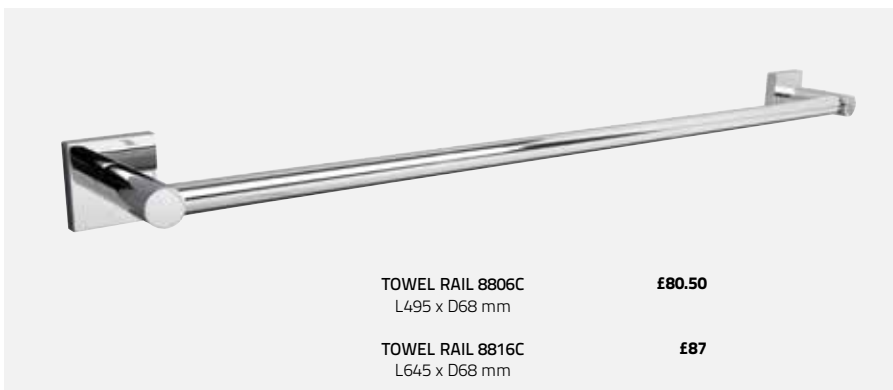

TOWEL RAIL 8806C £80.50
L495 x D68 mm

TOWEL RAIL 8816C £87
L645 x D68 mm



£75.25

TOILET ROLL HOLDER 8837C
W190 x H70 mm



£130

TOWEL RAIL 8827C
Double
L645 x D155 mm



Screws are included. This collection can also be fixed with our Fixing Adhesive.

We recommend that towel rails, glass shelves, mirrors, toilet brush sets, grab bars and products that carry heavy weight are screw fixed.



10 year Guarantee

Read more about the Miller Way on www.millerbathrooms.co.uk



'Full-fix 'anti twist' is a fixing system which prevents the accessory from turning when fitted.



Fixing Adhesive £16
Fixing Adhesive code no. 8798
Glue always sold separately.
Read more on millerbathrooms.co.uk

LEARN MORE

Find more matching items within the Classic Collection. Page 46.

For detailed measurements please see www.millerbathrooms.co.uk

Backplate 45 x 45 mm



ATLANTA BLACK

Atlanta's pure form and function provides a perfect balance of design and practicality. Benefiting from our full-fix system, this beautiful, matt black collection, provides everything you could wish for the finishing of your bathroom.



Screws are included. This collection can also be fixed with our Fixing Adhesive.

We recommend that towel rails, glass shelves, mirrors, toilet brush sets, grab bars and products that carry heavy weight are screw fixed.



10 year Guarantee

Read more about the Miller Way on www.millerbathrooms.co.uk



Full-fix 'anti twist' is a fixing system which prevents the accessory from turning when fitted.



Fixing Adhesive £16
Fixing Adhesive code no. 8798
Glue always sold separately.
Read more on millerbathrooms.co.uk

LEARN MORE

Find more matching Matt Black items within the Classic Collection. Page 46.

For detailed measurements please see www.millerbathrooms.co.uk

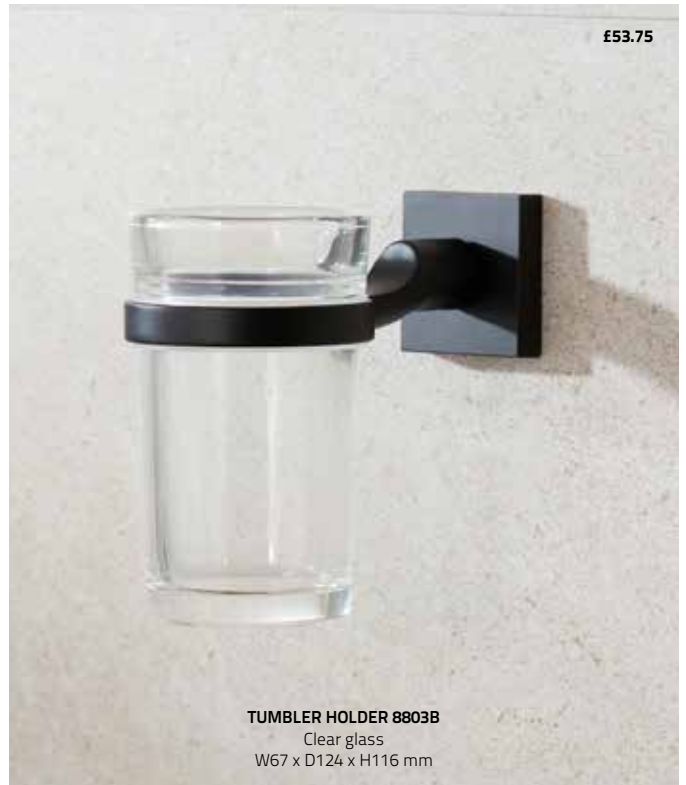

BOND

A modern day classic collection featuring pure, simple clean lines, finished in polished chrome with complementary glass component parts. Bond benefits from our full-fix system to prevent twisting, making it even more desirable and the perfect range for today's modern home.



£47.25

TOILET ROLL HOLDER 8710C
W150 x H105 mm



£61.25

TOILET ROLL HOLDER 8707C
with lid
W135 x H145 mm



£75.25

DOUBLE POST TOILET ROLL HOLDER 8737C
W205 x D70 mm

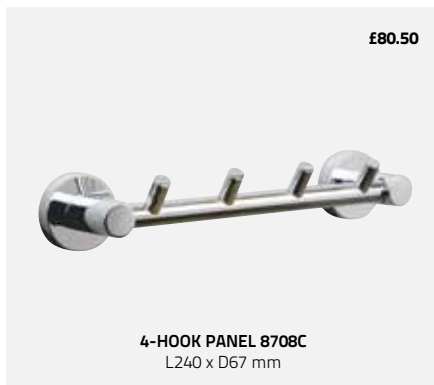

£80.50

4-HOOK PANEL 8708C
L240 x D67 mm



£58

SPARE ROLL HOLDER 8719C
H155 x D70 mm



TOWEL RAIL 8706C **£75.25**
L495 x D80 mm

TOWEL RAIL 8716C **£82.75**
L645 x D80 mm

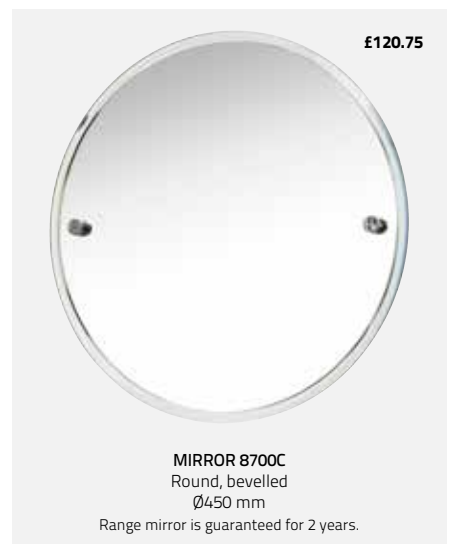

£120.75

MIRROR 8700C
Round, bevelled
Ø450 mm
Range mirror is guaranteed for 2 years.



£121.25

TOWEL RAIL 8727C
Double
L645 x D155 mm



Screws are included. This collection can also be fixed with our Fixing Adhesive.

We recommend that towel rails, glass shelves, mirrors, toilet brush sets, grab bars and products that carry heavy weight are screw fixed.



10 year Guarantee

Read more about the Miller Way on www.millerbathrooms.co.uk



'Full-fix 'anti twist' is a fixing system which prevents the accessory from turning when fitted.



Fixing Adhesive £16
Fixing Adhesive code no. 8798
Glue always sold separately.
Read more on millerbathrooms.co.uk

LEARN MORE

Find more matching items within the Classic Collection. Page 46.

For detailed measurements please see www.millerbathrooms.co.uk



BOND BLACK

A modern day classic collection featuring pure, simple clean lines, finished in matt black colour with complementary glass component parts. Bond benefits from our full-fix system to prevent twisting, making it even more desirable and the perfect range for today's modern home.



£51.50

TOILET ROLL HOLDER 8710B
W150 x H105 mm



Also available as a corner basket

Total £106.25



D-SHAPED BASKET 866B £96.75
GLUABLE WALL BRACKETS 2-PACK BG1 £9.50
Suitable for straight wall application, With practical hook
W250 x H80 x D125 mm
MATT BLACK FINISH



Available in lengths 300, 400, 500, 600 mm

Total £104.50

GLASS SHELF L400 MM 81024 £34.75
BRACKET 8102B £69.75
Total length 400 mm
MATT BLACK FINISH



£51.50

SOAP DISH 8704B
Clear glass
Ø110 x D145 mm



£125

SHELF 8702B
Guard rail in black finish, clear hardened glass
L500 x D120 mm



£51.50

TUMBLER HOLDER 8703B
Clear glass
H100 x D130 mm



TOWEL RAIL 8706B
L495 x D80 mm

£83.25

TOWEL RAIL 8716B
L645 x D80 mm

£89.75



Screws are included. This collection can also be fixed with our Fixing Adhesive.

We recommend that towel rails, glass shelves, mirrors, toilet brush sets, grab bars and products that carry heavy weight are screw fixed.



10 year Guarantee

Read more about the Miller Way on www.millerbathrooms.co.uk



'Full-fix 'anti twist' is a fixing system which prevents the accessory from turning when fitted.



Fixing Adhesive £16
Fixing Adhesive code no. 8798
Glue always sold separately.
Read more on millerbathrooms.co.uk

LEARN MORE

Find more matching items within the Classic Collection. Page 46.

For detailed measurements please see www.millerbathrooms.co.uk

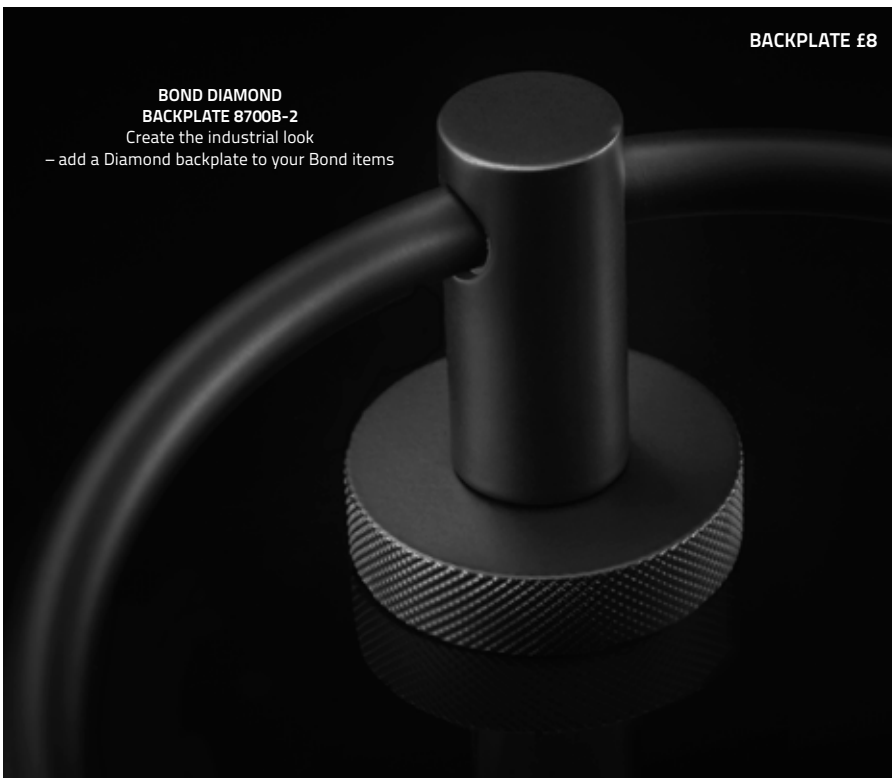
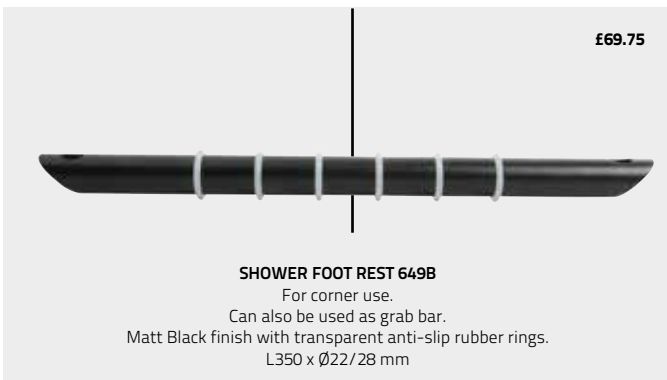

BOND BRUSHED BRASS

A modern day classic collection featuring pure, simple clean lines, finished in brushed laquered brass with complementary glass component parts. Bond benefits from our full-fix system to prevent twisting, making it even more desirable and the perfect range for today's modern home.

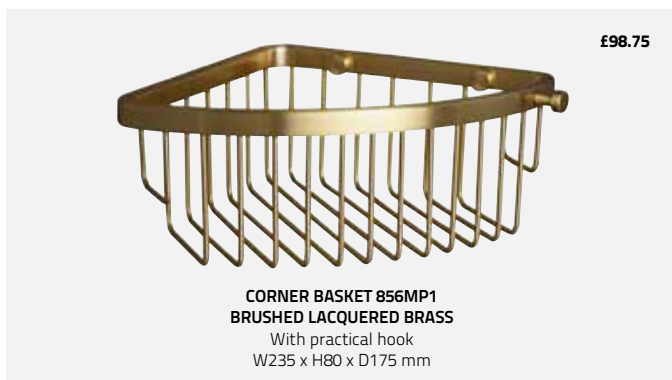
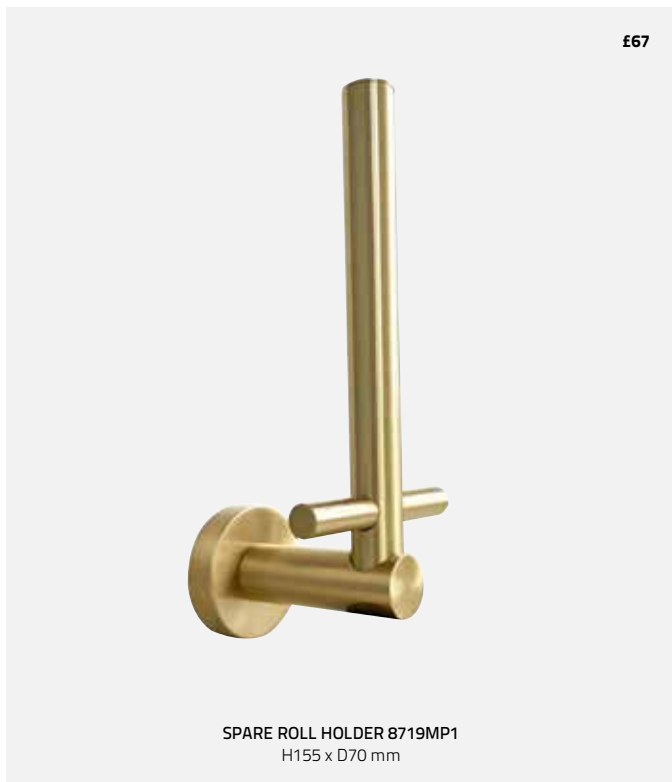

Screws are included. This collection can also be fixed with our Fixing Adhesive.

We recommend that towel rails, glass shelves, mirrors, toilet brush sets, grab bars and products that carry heavy weight are screw fixed.



10 year Guarantee

Read more about the Miller Way on www.millerbathrooms.co.uk



Full-fix 'anti twist' is a fixing system which prevents the accessory from turning when fitted.



Fixing Adhesive £16
Fixing Adhesive code no. 8798
Glue always sold separately.
Read more on millerbathrooms.co.uk

LEARN MORE

Find more matching items within the Classic Collection. Page 46.

For detailed measurements please see www.millerbathrooms.co.uk

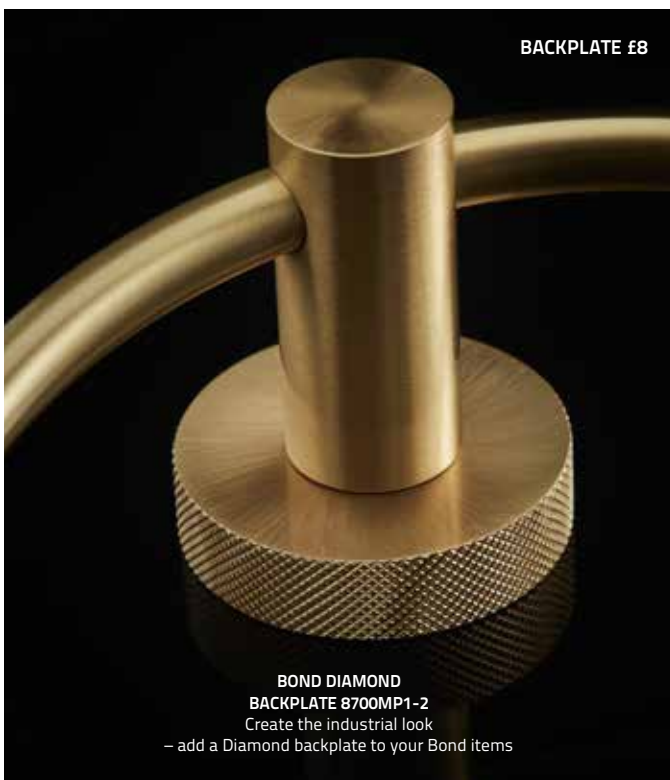

BOND POLISHED BRASS

These accessories are made of polished untreated brass and a beautiful patina is created over time. Match with our handles and taps in the same finish.

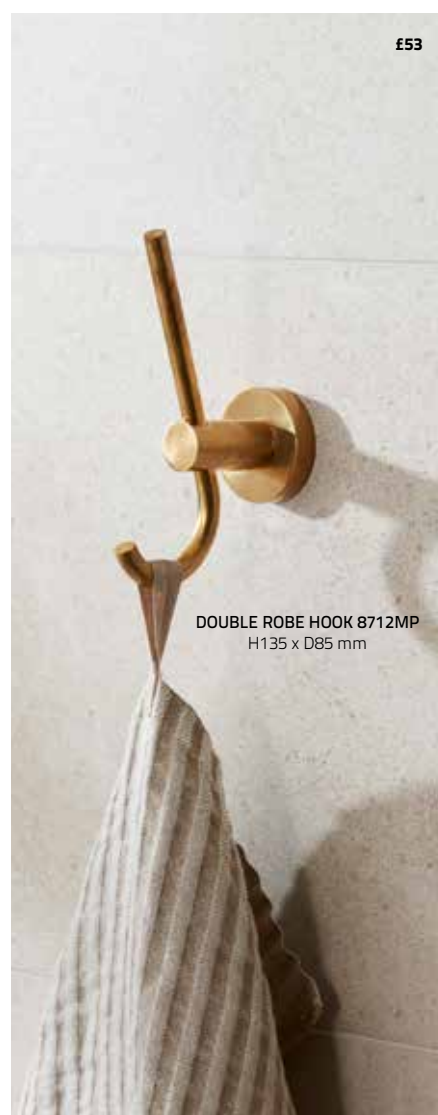

Screws are included. This collection can also be fixed with our Fixing Adhesive.

We recommend that towel rails, glass shelves, mirrors, toilet brush sets, grab bars and products that carry heavy weight are screw fixed.



10 year Guarantee

Read more about the Miller Way on www.millerbathrooms.co.uk



Full-fix 'anti twist' is a fixing system which prevents the accessory from turning when fitted.



Fixing Adhesive £16
Fixing Adhesive code no. 8798
Glue always sold separately.
Read more on millerbathrooms.co.uk

LEARN MORE

Find more matching items within the Classic Collection. Page 46.

For detailed measurements please see www.millerbathrooms.co.uk

Polished Untreated Brass with a living surface. Beautiful patina is created over time.
Backplate diameter Ø45 mm

Total £108.25



D-SHAPED BASKET 866MP £98.75
GLUABLE WALL BRACKETS 2-PACK MPG1 £9.50
 Suitable for straight wall application, With practical hook
 W250 x H80 x D125 mm
POLISHED UNTREATED BRASS



£98.75



SCREW FIXED D-SHAPED BASKET 866MP
POLISHED UNTREATED BRASS
 Suitable for straight wall application
 With practical hook
 W250 x H80 x D120 mm

Total £108.25



GLUABLE CORNER BASKET 856MP £98.75
GLUABLE WALL BRACKETS 2-PACK MPG1 £9.50
 With practical hook
 W235 x H80 x D175 mm
POLISHED UNTREATED BRASS



£98.75



SCREW FIXED CORNER BASKET 856MP
POLISHED UNTREATED BRASS
 With practical hook
 W235 x H80 x D175 mm

Total £100.75



GLASS SHELF 300 MM 810230 £30
BRACKET 8102MP £70.75
 L300 mm
POLISHED UNTREATED BRASS

Total £113.75



GLASS SHELF 500 MM 810250 £43
BRACKET 8102MP £70.75
 L500 mm
POLISHED UNTREATED BRASS

Total £105.5



GLASS SHELF 400 MM 810240 £34.75
BRACKET 8102MP £70.75
 L400 mm
POLISHED UNTREATED BRASS

Total £119



GLASS SHELF 600 MM 810260 £48.25
BRACKET 8102MP £70.75
 L600 mm
POLISHED UNTREATED BRASS

BOSTON

Architecturally inspired to produce a stunning image of sharp, clean angles and industrial style effects, the Boston collection benefits from full-fix fittings and is manufactured from solid brass. Its striking chrome lustre and beautiful ceramic components help to create a new contemporary classic.



£112.75

LOTION BOTTLE 8134C
White ceramic
W75 x H175 x D110 mm



£44

DOUBLE HOOK 8123C
W100 x H30 x D56 mm



£69.75

TUMBLER HOLDER 8103C
Tumbler in white ceramic
W80 x H115 x D105 mm



SWIVEL TOILET ROLL HOLDER 8107C £64.50
Swivel arm. Right or Left arm positioning.
W146 x H62 x D74 mm



£69.75

SOAP DISH 8104C
Dish in white ceramic
W125 x H40 x D130 mm



Screws are included. This collection can also be fixed with our Fixing Adhesive.

We recommend that towel rails, glass shelves, mirrors, toilet brush sets, grab bars and products that carry heavy weight are screw fixed.



Lifetime Guarantee

Read more about the Miller Way on www.millerbathrooms.co.uk



'Full-fix 'anti twist' is a fixing system which prevents the accessory from turning when fitted.



Fixing Adhesive £16
Fixing Adhesive code no. 8798
Glue always sold separately.
Read more on millerbathrooms.co.uk

LEARN MORE

Find more matching items within the Classic Collection. Page 46.

For detailed measurements please see www.millerbathrooms.co.uk



DENVER

Denver is a statement of style. Drawing its inspiration from cubism, this forged brass collection softens hard lines with soft curves to produce a truly eclectic mix of shapes. With the added feature of the full-fix system. Denver epitomises 'bathroom architecture'. All products in chrome finish.



Screws are included. This collection can also be fixed with our Fixing Adhesive.

We recommend that towel rails, glass shelves, mirrors, toilet brush sets, grab bars and products that carry heavy weight are screw fixed.



Lifetime Guarantee

Read more about the Miller Way on www.millerbathrooms.co.uk



Full-fix 'anti twist' is a fixing system which prevents the accessory from turning when fitted.



Fixing Adhesive £16
Fixing Adhesive code no. 8798
Glue always sold separately.
Read more on millerbathrooms.co.uk

LEARN MORE

Find more matching items within the Classic Collection. Page 46.

For detailed measurements please see www.millerbathrooms.co.uk

£137.50



MIRROR 6400C
Brushed bevelled edge
W420 x H500 mm
Range mirror is guaranteed for 12 months

£62.75



TOWEL RING 6405C
W178 x H150 mm



TOWEL RAIL 6406C **£97.25**
L490 x D75 mm

TOWEL RAIL 6416C **£102**
L650 x D75 mm



£154.75

DOUBLE TOWEL RAIL 6427C
L650 x D132 mm

£34.75



SINGLE ROBE HOOK 6411C
D54 mm

£41



DOUBLE ROBE HOOK 6423C
W50 x D50 mm

METRO

Metro is an exceptional range of innovative brass accessories, finished in chrome and complemented by a satin chrome decorative ring on the back plate. Featuring frosted glass component parts, the stylish 'mixage' finish creates an outstanding collection of contemporary products.

£55.75



TOILET ROLL HOLDER 6310C-S
W170 x D55 mm

£55.75



TOWEL RING 6305C-S
Ø155 mm

£59



SPARE ROLL HOLDER 6319C-S
H160 mm

£53.75



SOAP DISH 6304C-S
Frosted glass
Ø110 x D130 mm



This collection is screwfixed.
Screws are included



10 year Guarantee

Read more about
the Miller Way on
www.millerbathrooms.co.uk

LEARN MORE

For detailed measurements
please see www.millerbathrooms.co.uk

Solid brass in chrome finish. With a decorative satin chrome ring.
Backplate 37 x 37 mm

£118.25



MIRROR 6300C-S
Frosted bevelled edge,
round mirror Ø450 mm
Range mirror is guaranteed for 2 years.

£145



DOUBLE TOWEL RAIL 6327C-S
L655 x D160 mm



TOWEL RAIL 6306C-S **£90.25**
L505 x D75 mm

TOWEL RAIL 6316C-S **£96.75**
L655 x D75 mm

£107.50



GLASS SHELF 6302C-S
L500 x D125 mm

£33.75



SINGLE ROBE HOOK 6311C-S
D50 mm

£43



DOUBLE ROBE HOOK 6323C-S
W80 x D50 mm

MIAMI CHROME

Miami's strong form and contemporary shape is both elegant and stylish. Created from solid brass, finished by hand and chrome plated to a very high standard. It features our full-fix wall fitting system to ensure your accessories will enhance your bathroom for many years to come.



Screws are included. This collection can also be fixed with our Fixing Adhesive.

We recommend that towel rails, glass shelves, mirrors, toilet brush sets, grab bars and products that carry heavy weight are screw fixed.



Lifetime Guarantee

Read more about the Miller Way on www.millerbathrooms.co.uk



Full-fix 'anti twist' is a fixing system which prevents the accessory from turning when fitted.



Fixing Adhesive £16
Fixing Adhesive code no. 8798
Glue always sold separately.
Read more on millerbathrooms.co.uk

LEARN MORE

For detailed measurements please see www.millerbathrooms.co.uk

Miami is also available in Matt Black finish and Stainless Steel finish.

Find more matching items within the Classic Collection. Page 46.

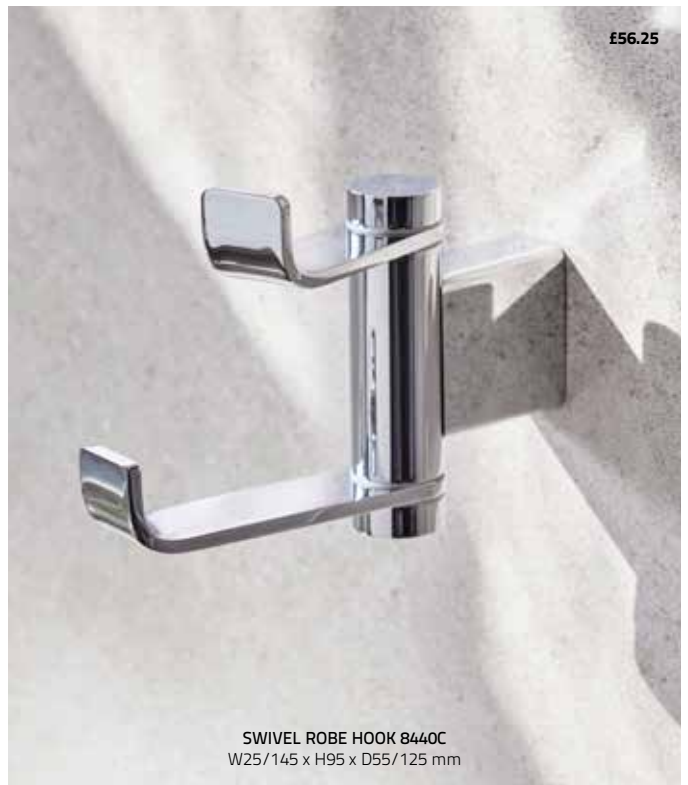

MIAMI BLACK



Screws are included. This collection can also be fixed with our Fixing Adhesive.

We recommend that towel rails, glass shelves, mirrors, toilet brush sets, grab bars and products that carry heavy weight are screw fixed.



Lifetime Guarantee

Read more about the Miller Way on www.millerbathrooms.co.uk



'Full-fix' 'anti twist' is a fixing system which prevents the accessory from turning when fitted.



Fixing Adhesive £16
Fixing Adhesive code no. 8798
Glue always sold separately.
Read more on millerbathrooms.co.uk

LEARN MORE

For detailed measurements please see www.millerbathrooms.co.uk

Miami is also available in Chrome and Stainless Steel finish.

Find more matching items within the Classic Collection. Page 46.



MIAMI STAINLESS STEEL

Solid brass in Stainless Steel finish.



Screws are included. This collection can also be fixed with our Fixing Adhesive.

We recommend that towel rails, glass shelves, mirrors, toilet brush sets, grab bars and products that carry heavy weight are screw fixed.



Lifetime Guarantee

Read more about the Miller Way on www.millerbathrooms.co.uk



Full-fix 'anti twist' is a fixing system which prevents the accessory from turning when fitted.



Fixing Adhesive £16
Fixing Adhesive code no. 8798
Glue always sold separately.
Read more on millerbathrooms.co.uk

LEARN MORE

For detailed measurements please see www.millerbathrooms.co.uk

Miami is also available in Chrome and Matt Black finish.

Find more matching items within the Classic Collection. Page 46.



MONTANA

Montana's contemporary styling perfectly accessorises today's modern bathrooms. Crafted from solid brass and hand finished. The range demonstrates a refreshing uniqueness of design. Montana also features the outstanding full-fix system, preventing your products from twisting.



Screws are included. This collection can also be fixed with our Fixing Adhesive.

We recommend that towel rails, glass shelves, mirrors, toilet brush sets, grab bars and products that carry heavy weight are screw fixed.



Lifetime Guarantee

Read more about the Miller Way on www.millerbathrooms.co.uk



'Full-fix 'anti twist' is a fixing system which prevents the accessory from turning when fitted.



Fixing Adhesive £16
Fixing Adhesive code no. 8798
Glue always sold separately.
Read more on millerbathrooms.co.uk

LEARN MORE

For detailed measurements please see www.millerbathrooms.co.uk

Find more matching items within the Classic Collection. Page 46.

£80.50



TOWEL RING 6725C
W140 x H180 mm

£246



DOUBLE TOWEL RAIL 6727C
L650 x H105 x D130 mm

£39.75



SINGLE HOOK 6711C
D50 mm

£244



MIRROR 6741C
Swivel, rectangular, bevelled
Total W500 x H500 mm
Mirror size W420 x H500 mm
Range mirror is guaranteed for 2 years.

£55.25



DOUBLE ROBE HOOK 6723C
W75 x D50 mm



L300 mm

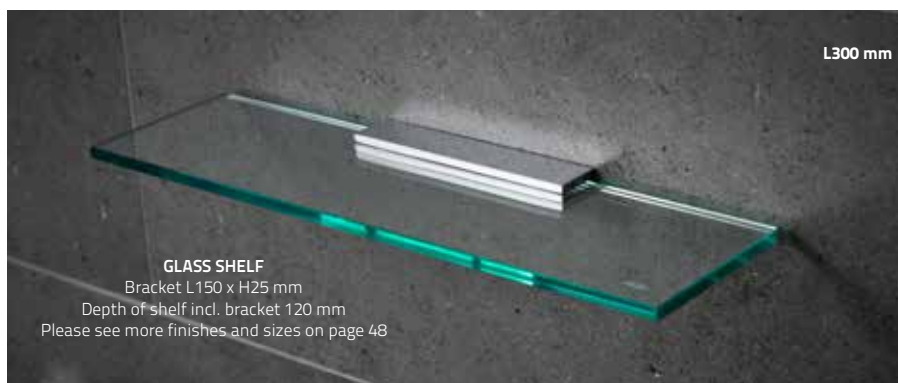

GLASS SHELF
Bracket L150 x H25 mm
Depth of shelf incl. bracket 120 mm
Please see more finishes and sizes on page 48

ORLANDO

Sweeping curves, crafted from solid brass and finished in sharp chrome, effortlessly combined with crisp, clean ceramic components are the key features of the Orlando collection. Unquestionably where modern style, combines with full-fix fittings to inspire an imperious range of products.



£112.75

LOTION BOTTLE 8134C
White ceramic
W75 x H175 x D110 mm



£50.50

ROBE HOOK 8212C
W22 x H115 x D87 mm



£41.75

HOOK 8211C
W22 x H61 x D68 mm

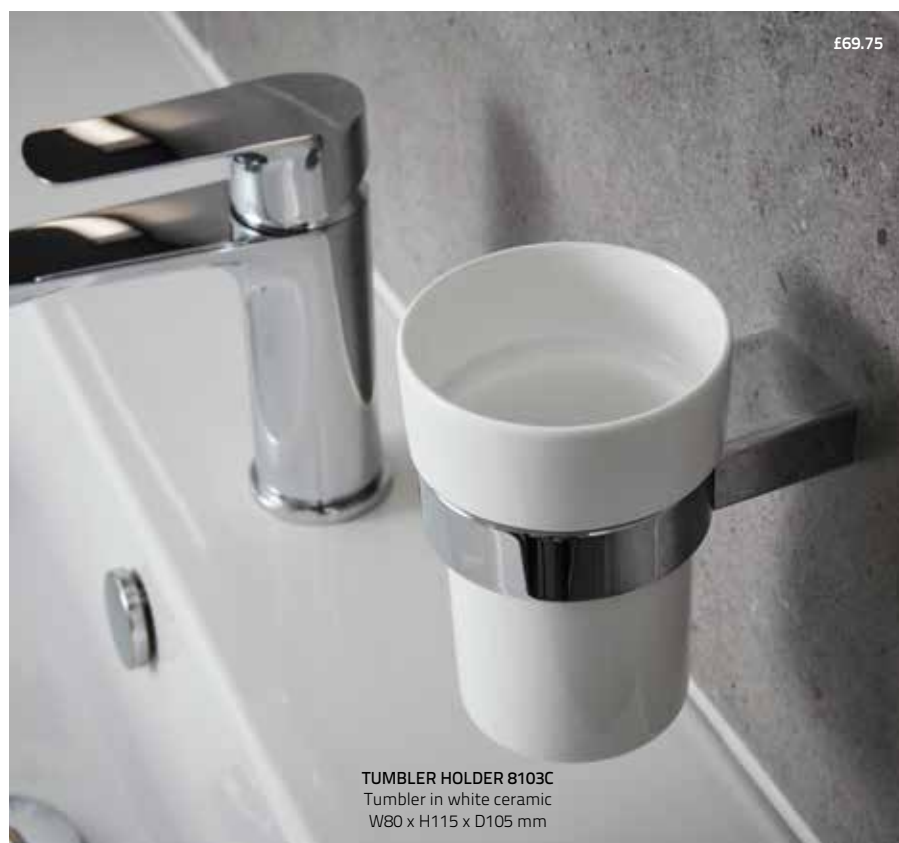

£69.75

TUMBLER HOLDER 8103C
Tumbler in white ceramic
W80 x H115 x D105 mm



£69.75

SOAP DISH 8104C
Dish in white ceramic
W125 x H40 x D130 mm



Screws are included. This collection can also be fixed with our Fixing Adhesive.

We recommend that towel rails, glass shelves, mirrors, toilet brush sets, grab bars and products that carry heavy weight are screw fixed.



Lifetime Guarantee

Read more about the Miller Way on www.millerbathrooms.co.uk



'Full-fix 'anti twist' is a fixing system which prevents the accessory from turning when fitted.

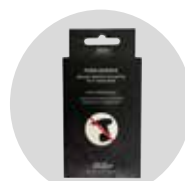

Fixing Adhesive £16
Fixing Adhesive code no. 8798
Glue always sold separately.
Read more on millerbathrooms.co.uk

LEARN MORE

For detailed measurements please see www.millerbathrooms.co.uk

Find more matching items within the Classic Collection. Page 46.

Solid brass in Chrome finish.

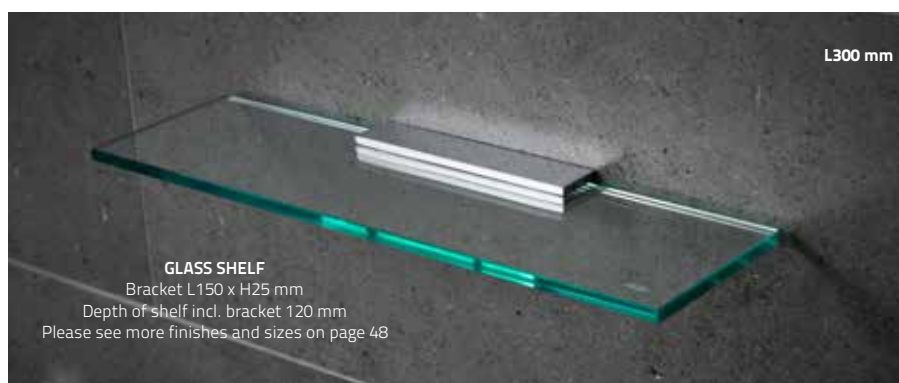
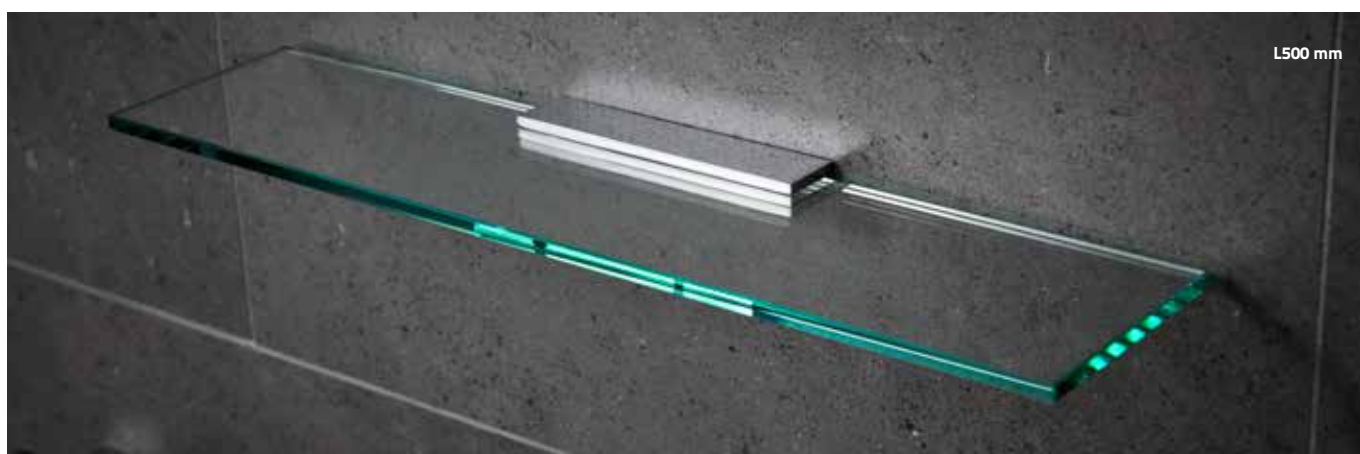

OSLO CHROME

Oslo's functional design, created in brass and finished in chrome, combined with its outstanding choice of items has made it the perfect collection for either a contemporary or a traditional setting.



Screws are included.
This collection can also be fixed with our Fixing Adhesive.

We recommend that towel rails, glass shelves, mirrors, toilet brush sets, grab bars and products that carry heavy weight are screw fixed.



10 year Guarantee

Read more about the Miller Way on www.millerbathrooms.co.uk



Fixing Adhesive £16
Fixing Adhesive code no. 8798
Glue always sold separately.
Read more on millerbathrooms.co.uk

LEARN MORE

For detailed measurements please see www.millerbathrooms.co.uk

Find more matching items within the Classic Collection. Page 46.

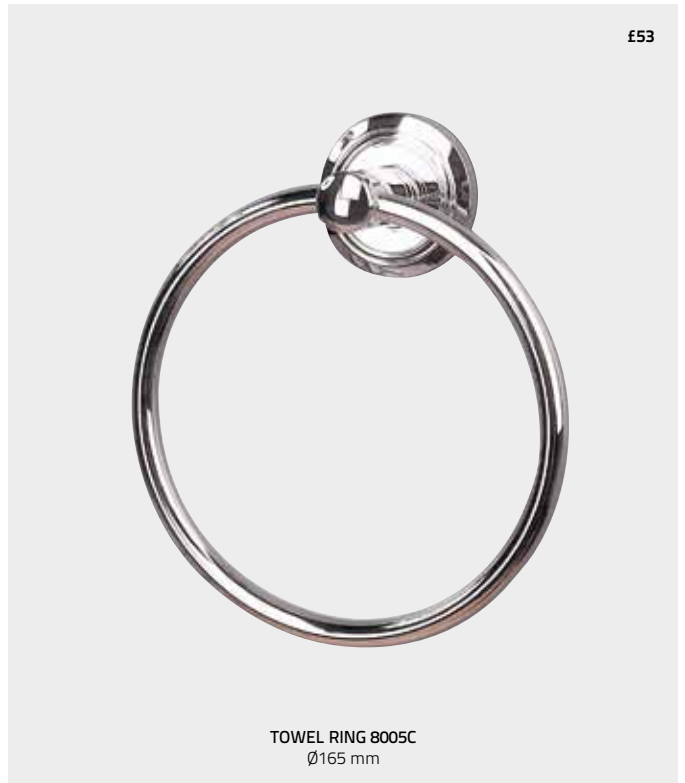
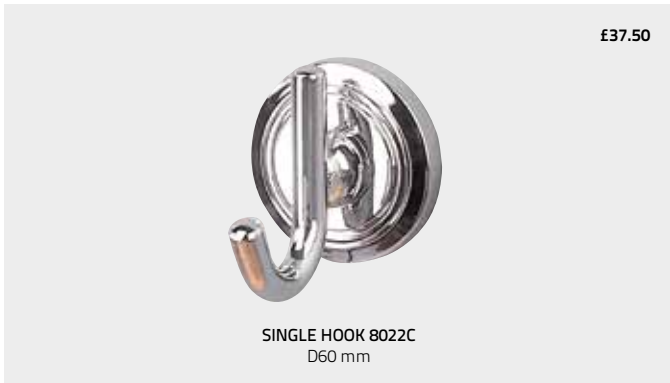

OSLO POLISHED NICKEL

Oslo is a classic range perfect for both contemporary and traditional bathrooms. Crafted from solid brass and finished in a polished nickel finish. Oslo is a range that definitely stands the test of time.

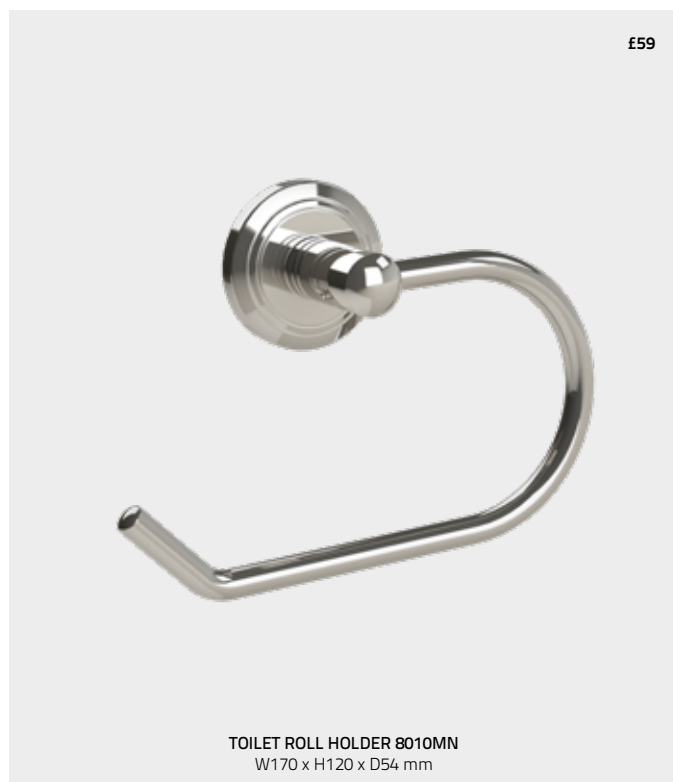

Screws are included. This collection can also be fixed with our Fixing Adhesive.

We recommend that towel rails, glass shelves, mirrors, toilet brush sets, grab bars and products that carry heavy weight are screw fixed.



10 year Guarantee

Read more about the Miller Way on www.millerbathrooms.co.uk



Fixing Adhesive £16
Fixing Adhesive code no. 8798
Glue always sold separately.
Read more on millerbathrooms.co.uk

LEARN MORE

For detailed measurements please see www.millerbathrooms.co.uk

£38.50



SINGLE HOOK 8022MN
D62 X H65 mm

£59



TOWEL RING 8005MN
H190 x W168 x D54 mm

£47.25



DOUBLE HOOK 8023MN
D58 x H62 mm

£172



DOUBLE TOWEL RAIL 8027MN
L655 x D150 mm

£92.25



TOWEL RAIL 8006MN
L505 x D75 mm

£117



TOILET BRUSH SET 8021MN
Wall-mounted, white ceramic bowl
H365 x Ø110 mm

£108.50

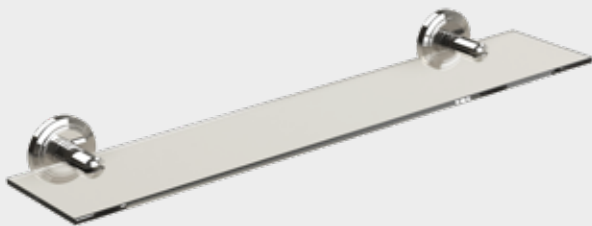

GLASS SHELF 8002MN
Clear hardened glass
L500 x D125 x H56 mm

£141.75



MIRROR 8000MN
Oval mirror W400 x H505 mm
Range mirror is guaranteed for 2 years.

RICHMOND

Richmond's stylish curves combine with modern manufacturing methods to create a perfect fusion. Crafted from solid brass, beautifully finished in hard wearing chrome and perfectly complemented with delicate, white ceramic components, the Richmond collection is truly a classic 'for today'.



£53.75

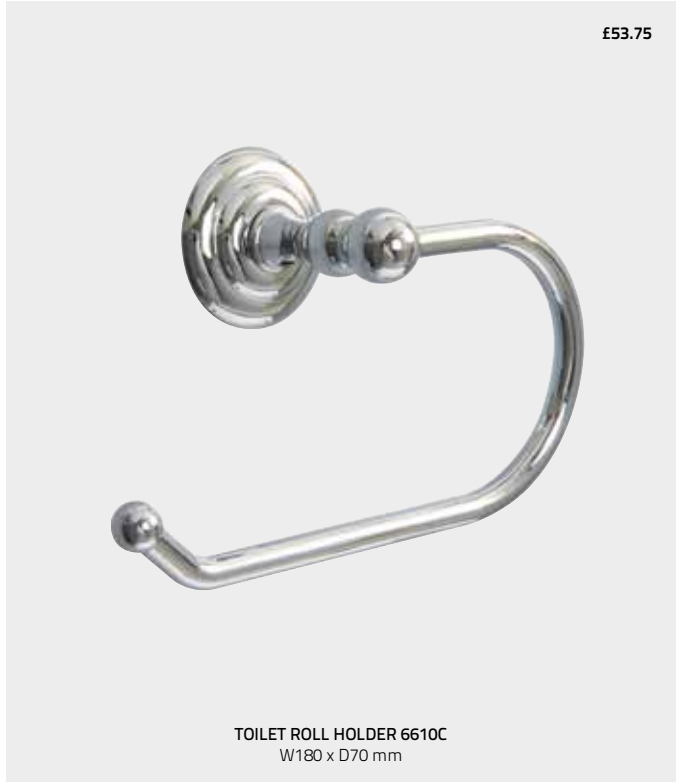

TOILET ROLL HOLDER 6610C
W180 x D70 mm



£59

TUMBLER HOLDER 6603C
White ceramic
H110 x D120 mm



£92.25

DOUBLE POST TOILET ROLL HOLDER 6637C
W220 x D70 mm



£59

SOAP DISH 6604C
White ceramic
H65 x D140 mm



Screws are included. This collection can also be fixed with our Fixing Adhesive.

We recommend that towel rails, glass shelves, mirrors, toilet brush sets, grab bars and products that carry heavy weight are screw fixed.



Lifetime Guarantee

Read more about the Miller Way on www.millerbathrooms.co.uk



'Full-fix 'anti twist' is a fixing system which prevents the accessory from turning when fitted.



Fixing Adhesive £16
Fixing Adhesive code no. 8798
Glue always sold separately.
Read more on millerbathrooms.co.uk

LEARN MORE

For detailed measurements please see www.millerbathrooms.co.uk

Find more matching items within the Classic Collection. Page 46.

£36.50



SINGLE HOOK 6622C
D80 mm

£53.75



TOWEL RING 6605C
Ø155 x D70 mm

£47.25



DOUBLE HOOK 6623C
W85 x D70 mm

£158



DOUBLE TOWEL RAIL 6627C
L655 x D150 mm

£92.25



TOWEL RAIL 6606C
L495 x D70 mm Length of rail 425 mm

£120.75



MIRROR 6600C
Bevelled edge,
W410 x H500 mm
Range mirror is guaranteed for 2 years.

£141.75



GLASS SHELF 6602C
Clear hardened glass
L500 x D125 x H56 mm

STOCKHOLM

Designed and developed in 1978, Stockholm is a timeless combination of classic quality and style. Crafted from solid brass and hand finished, this traditional collection is complemented by ceramic component parts. With its extensive range of items, Stockholm offers the perfect answer for any bathroom setting.



This collection is screwfixed.
Screws are included



Lifetime Guarantee

Read more about
the Miller Way on
www.millerbathrooms.co.uk

LEARN MORE

For detailed measurements
please see www.millerbathrooms.co.uk

Find more matching items
within the Classic Collection. Page 46.

Finishes Available 

Chrome finish or selected items in polished untreated brass
White ceramic details

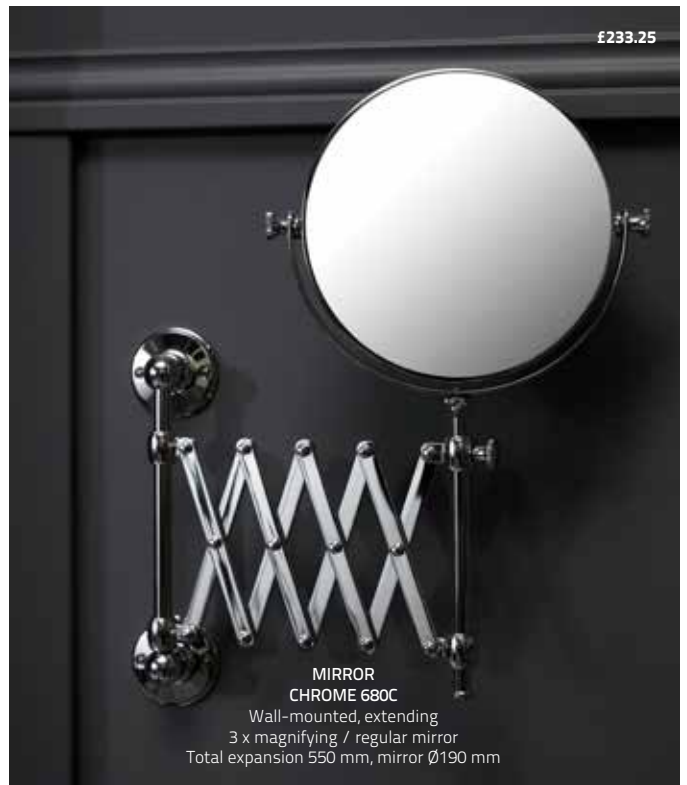

STOCKHOLM

£60



TOWEL RING
CHROME 605C
POLISHED BRASS 605MP
Ø145 mm



£199.50



DOUBLE TOWEL RAIL
CHROME 627C
POLISHED BRASS 627MP
L720 x H135 mm



£60



TOWEL RING
CHROME 605C
POLISHED BRASS 605MP
Ø145 mm



£179.50



DOUBLE TOWEL RAIL
CHROME 617C
L545 x H135 mm

£95.50



TOWEL RAIL
CHROME 606C
L545 x H75 mm

£166.50

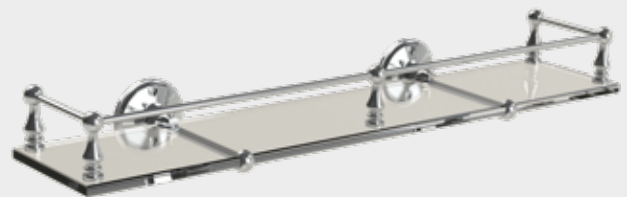

SHELF
CHROME 602C
POLISHED BRASS 602MP
Clear glass with rail
L500 x D150 mm



£18.25



TOILET SIGN
CHROME 722C
Oval sign, chrome finish
W80 x H45 mm

£18.25



BATHROOM SIGN
CHROME 723C
Oval sign, chrome finish
W80 x H45 mm

Finishes Available



Chrome finish or selected items in polished untreated brass
White ceramic details

£334.25



MIRROR
CHROME 642C
POLISHED BRASS 642MP
Framed swivel, polished bevelling
W545 x H610 mm



£60



TOILET ROLL HOLDER
CHROME 610C
POLISHED BRASS 610MP
Ø145 mm



£108.50



WALL HUNG TOILET BRUSH SET
CHROME 628C
White ceramic
Ø110 x H400 mm



CLASSIC

The Classic Accessory Collection is a select range of creative and practical products. Designed and developed with careful attention to detail, this diverse collection offers solutions in a stylish and thoughtful way.



Screws are included. Products with this symbol can also be fixed with our Fixing Adhesive.

We recommend that towel rails, glass shelves, mirrors, toilet brush sets, grab bars and products that carry heavy weight are screw fixed.



10 year Guarantee

Read more about the Miller Way on www.millerbathrooms.co.uk

LEARN MORE

For detailed measurements please see www.millerbathrooms.co.uk



£233.25



MIRROR 680C

Wall mounted, 3 x magnification/regular mirror
Max extension 550 mm, Ø190 mm

£118.25



**MIRROR
CHROME 681C
POLISHED BRASS 681MP**



Wall mounted, 3 x magnification/regular mirror
Max extension 350 mm, Ø190 mm

£174



TABLE MIRROR 688C

Polished bevelling. One-sided mirror
W279 x D130 x H340 mm

£82.75



MIRROR 27201C

Wall mounted, 3 x magnification
/regular mirror
Ø190 mm

£149.25



MIRROR 8781C

Wall mounted, 3 x magnification/regular mirror
Maximum extension 350 mm, Ø190 mm

£118.25



MIRROR 682C

3 x magnification/regular mirror
H405 mm, Ø190 mm

CLASSIC

GLASS SHELF x 4 LENGTHS: 300, 400, 500, 600 MM
x 5 FINISHES

8 mm clear hardened glass
Solid brass bracket
Bracket measurement L150 x H25 x D30 mm
Depth of shelf incl. bracket 120 mm

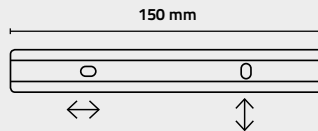

Screw holes in the bracket for easy adjustable fixing

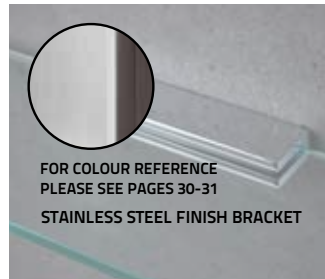

Total £100.75



GLASS SHELF 300 MM 810230 £30
BRACKET 8102MP £70.75
L300 mm
POLISHED UNTREATED BRASS

Total £105.50



GLASS SHELF 400 MM 810240 £34.75
BRACKET 8102MP £70.75
L400 mm
POLISHED UNTREATED BRASS

Total £113.75



GLASS SHELF 500 MM 810250 £43
BRACKET 8102MP £70.75
L500 mm
POLISHED UNTREATED BRASS

Total £119



GLASS SHELF 600 MM 810260 £48.25
BRACKET 8102MP £70.75
L600 mm
POLISHED UNTREATED BRASS

Total £99.75



GLASS SHELF 300 MM 810230 £30
BRACKET 8102B £69.75
L300 mm
MATT BLACK

Total £104.50



GLASS SHELF 400 MM 810240 £34.75
BRACKET 8102B £69.75
L400 mm
MATT BLACK

Total £112.75



GLASS SHELF 500 MM 810250 £43
BRACKET 8102B £69.75
L500 mm
MATT BLACK

Total £118



GLASS SHELF 600 MM 810260 £48.25
BRACKET 8102B £69.75
L600 mm
MATT BLACK

Total £99.75



GLASS SHELF 300 MM 810230 £30
BRACKET 8102MP1 £69.75
L300 mm
BRUSHED BRASS

Total £104.50



GLASS SHELF 400 MM 810240 £34.75
BRACKET 8102MP1 £69.75
L400 mm
BRUSHED BRASS

Total £112.75



GLASS SHELF 500 MM 810250 £43
BRACKET 8102MP1 £69.75
L500 mm
BRUSHED BRASS

Total £118



GLASS SHELF 600 MM 810260 £48.25
BRACKET 8102MP1 £69.75
L600 mm
BRUSHED BRASS

Total £99.75



GLASS SHELF 300 MM 810230 £30
BRACKET 8102BN £69.75
L300 mm
STAINLESS STEEL FINISH

Total £104.50



GLASS SHELF 400 MM 810240 £34.75
BRACKET 8102BN £69.75
L400 mm
STAINLESS STEEL FINISH

Total £112.75



GLASS SHELF 500 MM 810250 £43
BRACKET 8102BN £69.75
L500 mm
STAINLESS STEEL FINISH

Total £118



GLASS SHELF 600 MM 810260 £48.25
BRACKET 8102BN £69.75
L600 mm
STAINLESS STEEL FINISH

GLASS SHELF

8 mm hardened clear glass, 2 chrome finished shelf brackets.

Depth of all shelves 114 mm.

291020 L300 mm **£55.25**

291120 L400 mm **£57.50**

291220 L450 mm **£58.50**

291320 L500 mm **£59.50**

291420 L600 mm **£61.75**



£59

CORNER SHELF 292320

8 mm hardened glass, 2 chrome finished shelf brackets
W200 x D200 mm



£60

CORNER SHELF 292020

8 mm hardened glass, 2 chrome finished shelf brackets
W200 x D114 mm



£106.25

CLOAKROOM SHELF 668C

6 mm hardened glass
Guard rail in chrome finish
W280 x D145 x H45 mm

CLASSIC





CLASSIC

£253.50



TOWEL RACK 667B
Wall mounted, one towel rail, Black finish
L620 x D235 x H185 mm

£265.50

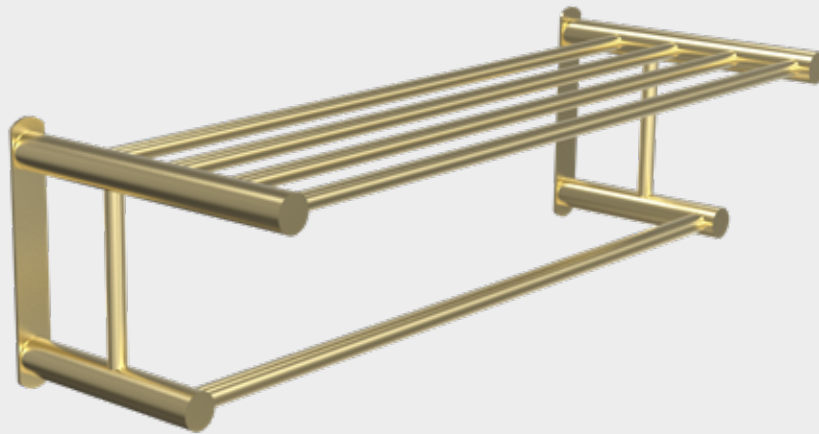

TOWEL RACK 667MP1
Wall mounted, one towel rail, Brushed Brass finish
L620 x D235 x H185 mm

£238.50

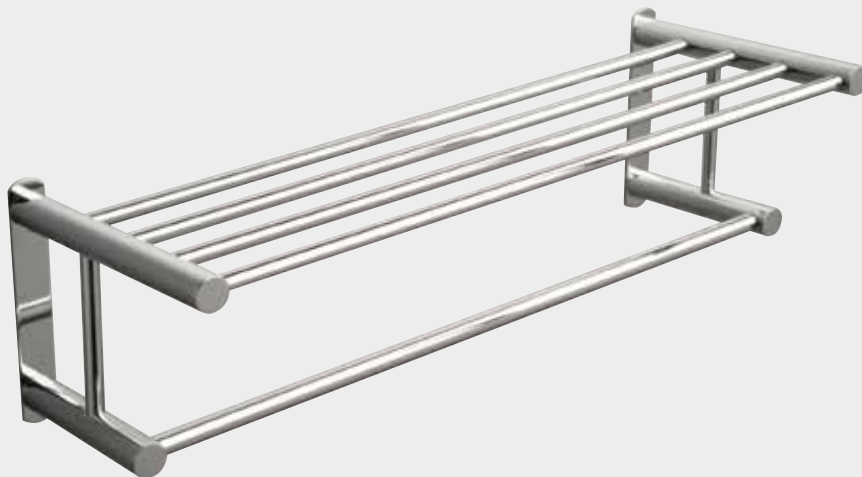

TOWEL RACK 667C
Wall mounted, one towel rail, Chrome finish
L620 x D235 x H185 mm



GRAB BAR

Concealed fixing \varnothing 25 mm

- 5670C** L360 mm Chrome finish **£84.75**
- 5670B** L360 mm Matt Black finish **£92.25**
- 5670MP1** L360 mm Brushed Brass finish **£95.50**
- 5671C** L460 mm Chrome finish **£91.25**
- 5672C** L560 mm Chrome finish **£96.75**



FOUR TIER SHELF 27054



£191.25

BATH RACK 662C

Chrome finish with white rubber details
W720 mm expand to 940 mm x D200 mm



£483.75



£18.25

BATHROOM SIGN 723C

Oval sign, chrome finish
W80 x H45 mm



£18.25

TOILET SIGN 722C

Oval sign, chrome finish
W80 x H45 mm

FOUR TIER SHELF 27054

4 clear glass shelves. Chrome finish
W350 H990 D280 mm

CLASSIC



£58

SHOWER DOOR & SCREEN FITTING 4-HOOK 832B
 Matt Black finish
 Suitable for glass thickness up to 10 mm
 L181 x D50 x H30 mm

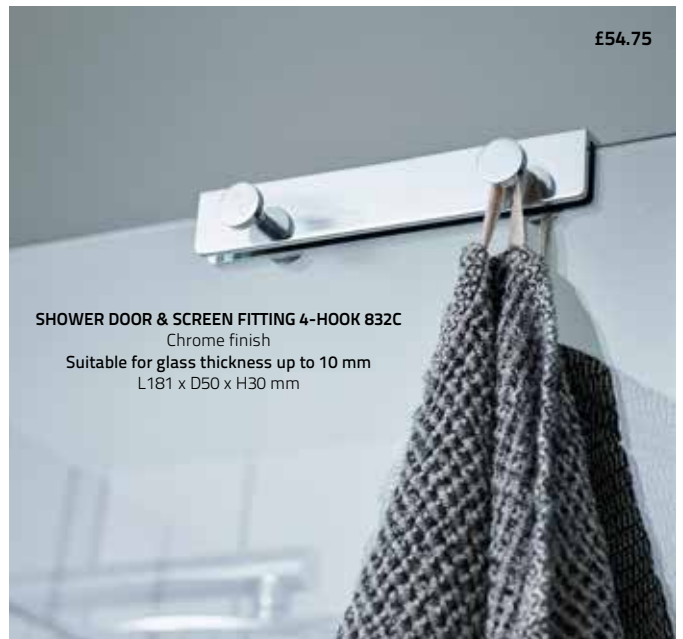

£54.75

SHOWER DOOR & SCREEN FITTING 4-HOOK 832C
 Chrome finish
 Suitable for glass thickness up to 10 mm
 L181 x D50 x H30 mm



£112.75



Parts included



Bracket with supplied tape



When mounted on a wall the holder angles outwards

FREE STANDING OR WALL HUNG
 (removable)

TOILET BRUSH SET 648B

Fix with screws or supplied tape. Spare Brush Head incl.
 Matt Black finish
 Ø85 x H380 mm



£134.25

PAPER AND SPARE ROLL HOLDER 5656B

Matt Black finish (Chrome Hinge)
 H568 mm
 Floor plate W200 x D135 mm

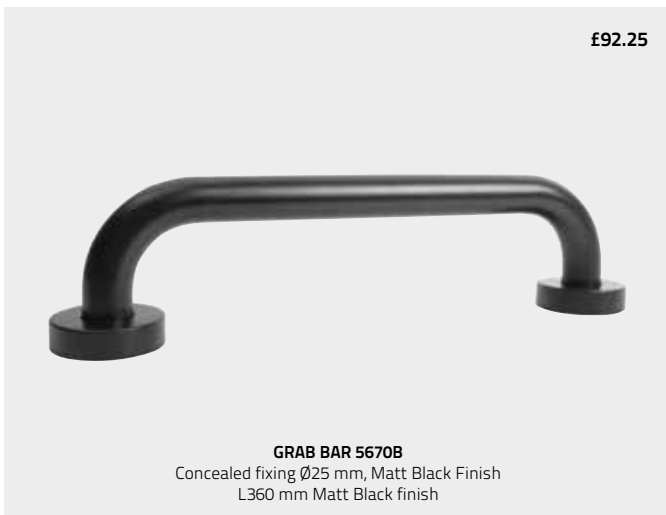

£92.25

GRAB BAR 5670B

Concealed fixing Ø25 mm, Matt Black Finish
 L360 mm Matt Black finish



£69.75

SHOWER FOOT REST 649B

For corner use.
 Can also be used as grab bar.
 Matt Black finish with transparent anti-slip rubber rings.
 L350 x Ø22/28 mm



£104.25

Parts included (image show 648B)

Bracket with supplied tape (image show 648B)

When mounted on a wall the holder angles outwards

FREE STANDING OR WALL HUNG
(removable)

TOILET BRUSH SET 648C
Fix with screws or supplied tape. Spare Brush Head incl.
Chrome finish
Ø85 x H380 mm





£317

TOWEL HORSE 646C
Free standing
W670 x D290 x H900 mm



£222.50

TOWEL HOLDER 5669CH
Free standing, Base 180 x 245 mm
Total W373 mm Total H860 mm

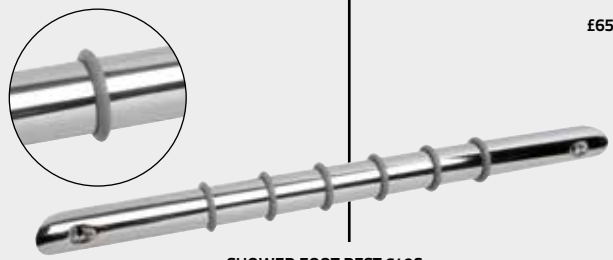

£65.50

SHOWER FOOT REST 649C
For corner use.
Can also be used as grab bar.
Chrome with transparent anti-slip rubber rings.
L350 x Ø22/28 mm



See more finishes on page 50 **£238.50**

TOWEL RACK 667C
Wall mounted, one towel rail, chrome finish
L620 x D235 x H185 mm

BASKETS

All baskets on this page have concealed screw fixings.
Baskets marked with no-drill symbol can be fixed with our fixing adhesive.
Adhesive is always sold separately, code.no. 8798



The Basket Collection is the pinnacle of luxurious showering accessories. We have selected the very best material to craft our wall mounted baskets, which all feature innovative, concealed fixings. Other features include a practical hook on some, while on others you will be able to remove them

for easy cleaning. Contemporary shower shelves add sophistication to the wet room environment, so popular today.

Our latest addition to this family of products are the 856 and 866 shower baskets that are gluable. Available in several finishes.



D-SHAPED BASKET 866C £89.75
GLUABLE WALL BRACKETS 2-PACK CG1 £9.50
CHROME FINISH
Suitable for straight wall application, With practical hook
W250 x H80 x D125 mm



SCREW FIXED D-SHAPED BASKET 866C £89.75
CHROME FINISH
Suitable for straight wall application
With practical hook
W250 x H80 x D120 mm



D-SHAPED BASKET 866B £96.75
GLUABLE WALL BRACKETS 2-PACK BG1 £9.50
MATT BLACK FINISH
Suitable for straight wall application, With practical hook
W250 x H80 x D125 mm

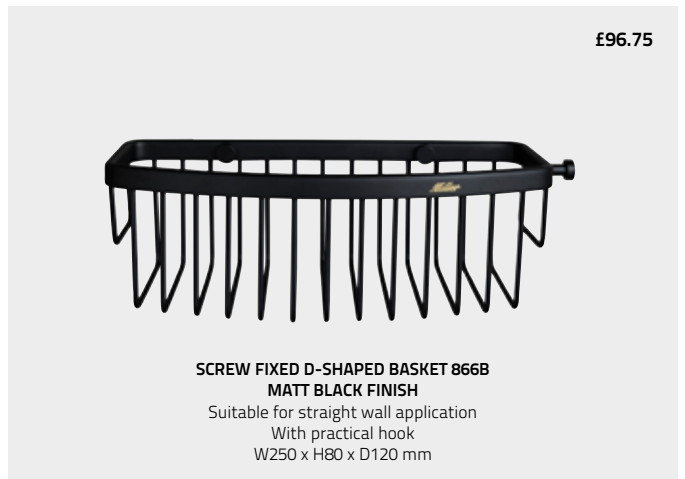

SCREW FIXED D-SHAPED BASKET 866B £96.75
MATT BLACK FINISH
Suitable for straight wall application
With practical hook
W250 x H80 x D120 mm



Polished Untreated Brass with a living surface. Beautiful patina is created over time.

D-SHAPED BASKET 866MP £98.75
GLUABLE WALL BRACKETS 2-PACK MPG1 £9.50
POLISHED UNTREATED BRASS
Suitable for straight wall application, With practical hook
W250 x H80 x D125 mm

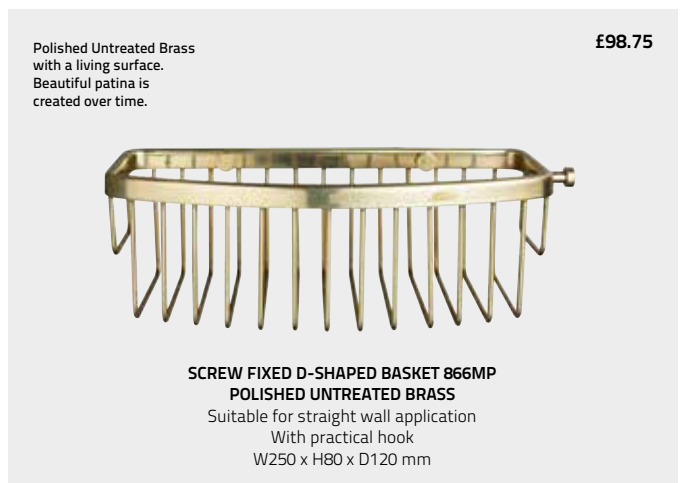

Polished Untreated Brass with a living surface. Beautiful patina is created over time.

SCREW FIXED D-SHAPED BASKET 866MP £98.75
POLISHED UNTREATED BRASS
Suitable for straight wall application
With practical hook
W250 x H80 x D120 mm

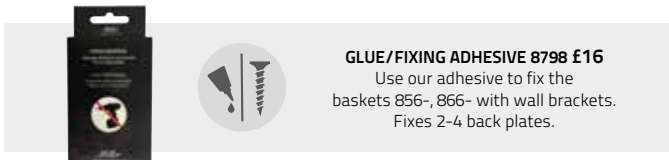

GLUE/FIXING ADHESIVE 8798 £16
Use our adhesive to fix the baskets 856-, 866- with wall brackets. Fixes 2-4 back plates.



Practical Hook on the side

All baskets on this page have concealed screw fixings.
 Baskets marked with no-drill symbol can be fixed with our fixing adhesive.
 Adhesive is always sold separately, code.no. 8798

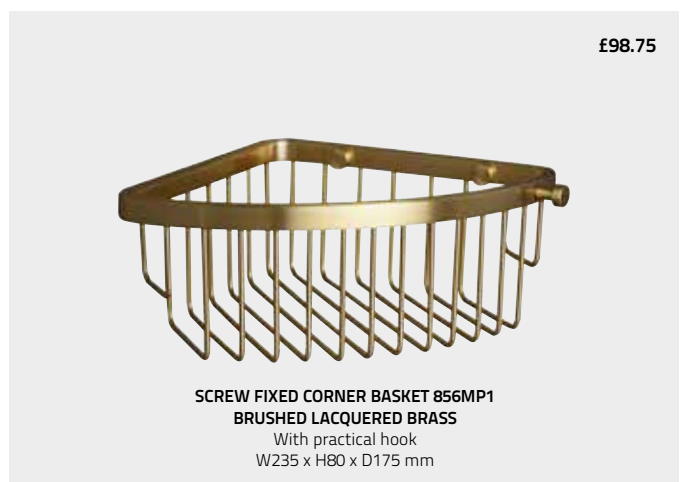
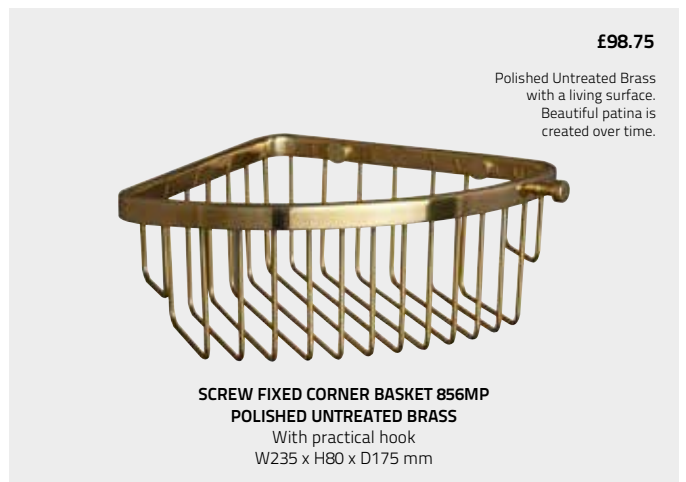

BASKETS

All baskets on this page have concealed screw fixings.

£68.25



CORNER SOAP BASKET 851C
 Chrome finish
 With practical hook
 W185 x H35 x D130 mm

£174



CORNER BASKET 855C
 Two tier
 Chrome finish
 With practical hook
 W235 x H310 x D175 mm

£196.50



CORNER BASKET 855MP1 Two tier
 Brushed Brass finish
 With practical hook
 W235 x H310 x D175 mm

£190.25



CORNER BASKET 855B Two tier
 Matt Black finish
 With practical hook
 W235 x H310 x D175 mm

£165.50



D-SHAPED BASKET 865C
 Chrome finish
 Suitable for straight wall application, two tier
 With practical hook
 W250 x H310 x D120 mm

£268.75



SHOWER CADDY 663C
 Chrome finish
 Two tier. No fixing needed.
 W235 x H650 x D125 mm
 Height of baskets 80 mm

All baskets on this page have concealed screw fixings.



£98.75

RECTANGULAR SHOWER TIDY 877C
Removable tray. Dishwasher tested.
W233 x H60 x D125 mm



£98.75

CORNER SHOWER TIDY 876C
Removable tray. Dishwasher tested.
W230 x H60 x D175 mm



£184.75

TWO TIER CORNER SHOWER TIDY 878C
Removable tray. Dishwasher tested.
W230 x H310 x D175 mm



£328.75

CORNER SHOWER BASKET 875C
Three tier
With practical hook
W235 x H540 x D175 mm
Height of baskets 80 mm



£165.50

CORNER SHOWER SHELF 864C
Angled. Practical hook.
W250 x H70 x D200 mm



OVAL BASKET
Suitable for straight wall application, removable for easy cleaning

867C W280 x H55 x D105 mm **£95.50**
868C W350 x H70 x D130 mm **£107.50**

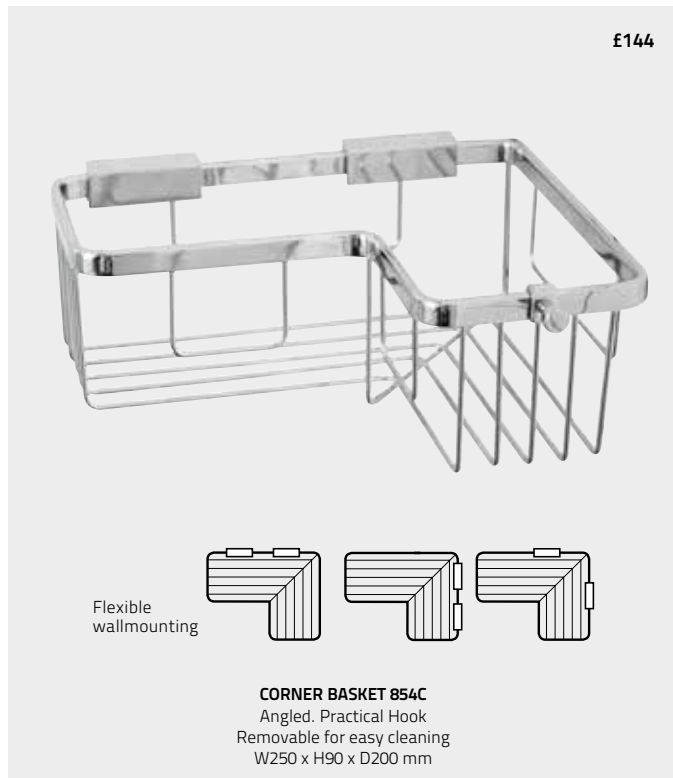

£144

Flexible wallmounting

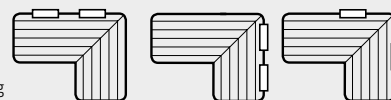

CORNER BASKET 854C
Angled. Practical Hook
Removable for easy cleaning
W250 x H90 x D200 mm

BASKETS

All baskets on this page have concealed screw fixings.
Baskets marked with no-drill symbol can be fixed with our fixing adhesive.
Adhesive is always sold separately, code.no. 8798



All baskets on this page have concealed screw fixings.



BASKETS

All baskets on this page have concealed screw fixings.



All baskets on this page have concealed screw fixings.



CLASSIC



CORNER BASKET 654C £77.25
Two tier, brass, chrome finish
W175 x D115 x H210 mm

CORNER BASKET 655C £104.25
Two tier, brass, chrome finish
W250 x D150 x H310 mm

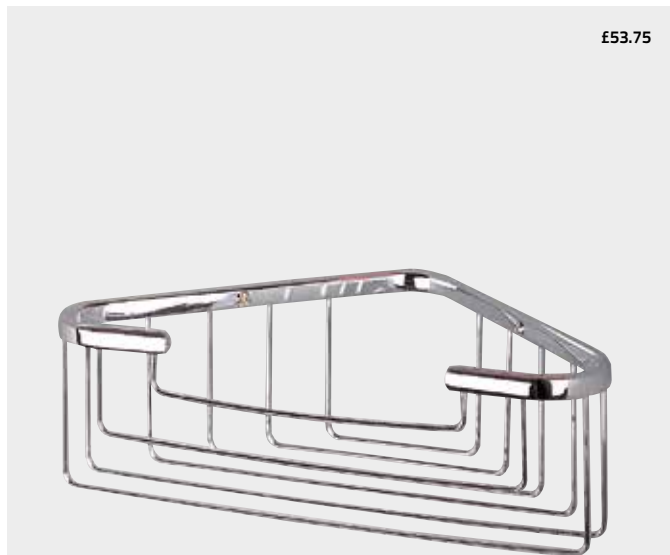

£53.75

CORNER BASKET 656C
Brass, chrome finish
W250 x D150 x H80 mm



£35.25

SOAP BASKET 650C
Brass, chrome finish
W130 x D95 x H35 mm



£46

CORNER BASKET 652C
Brass, chrome finish
W250 x D150 x H55 mm



£35.25

CORNER BASKET 651C
Brass, chrome finish
W175 x D115 x H35 mm



£137.50

SHOWER SHELF 664C
Stainless steel shelf, removable for easy cleaning. Can also be fixed to the wall with adhesive, sold separately code.no 8798
W315 x D130 x H85 mm



£70.75

BASKET 653C
Brass, chrome finish
W265 x D125 x H45 mm

CLASSIC LIGHT PULL

Classic accessories packaging can be easily found through this colour.

The Classic Light Pull Collection is both stylish yet practical. Manufactured from solid brass with several items featuring complementary ceramic or wood parts, all these pulls are supplied with white cord for easy fitting.

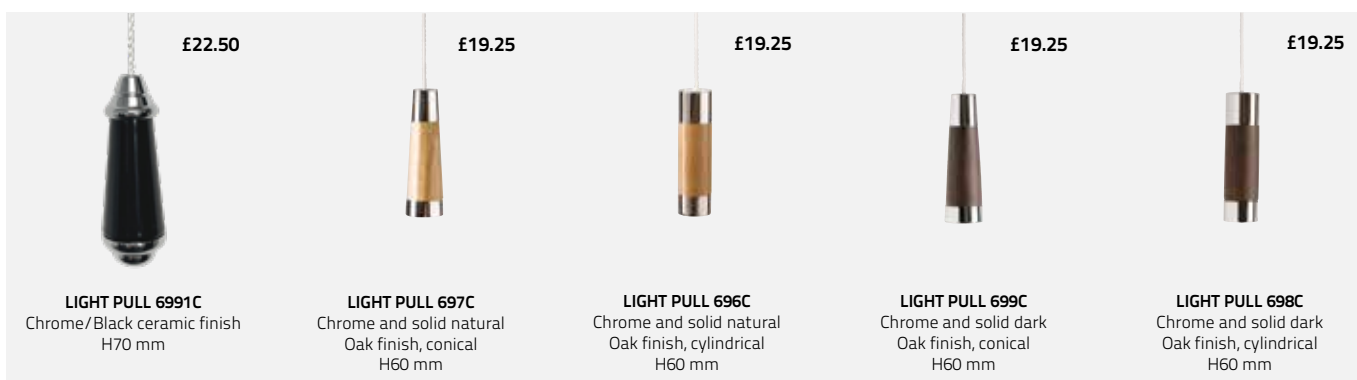
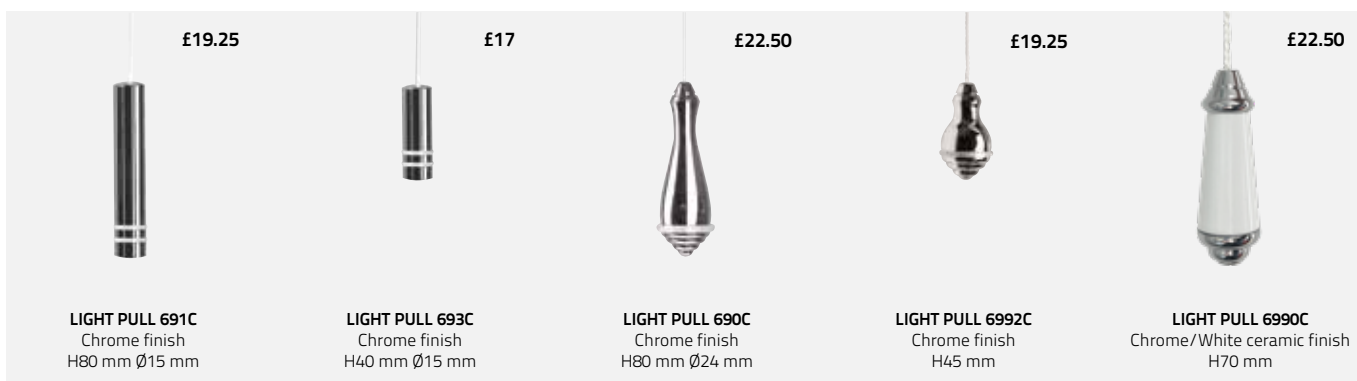

CUBE

Backplate 60 x 60 mm, Chrome finish



Glass Shelf C02
Clear Glass
L500 x D140 mm

£47.75



Soap Dish C04
Clear glass
H60 x D130 mm

£24.50



Lotion Bottle C34
Frosted glass
H160 x D110 mm

£34.25



Tumbler Holder C03
Clear glass
H110 x D110 mm

£24.50



Towel Ring C05
Ø155 mm
H180 x D55 mm

£23.50



Double Hook C23
D55 mm

£19.25



Towel Rail C06
Length of rail 430 mm
L505 x D70 mm

£37.50



Single Robe Hook C11
D55 mm

£17



Toilet Roll Holder C10
W170 x H110 mm

£23.50



Screws are included. This collection can also be fixed with our Fixing Adhesive.

We recommend that towel rails, glass shelves, mirrors, toilet brush sets, grab bars and products that carry heavy weight are screw fixed.



2 year Guarantee

Read more about the Miller Way on www.millerbathrooms.co.uk



Fixing Adhesive £16
Fixing Adhesive code no. 8798
Glue always sold separately.
Read more on millerbathrooms.co.uk

LEARN MORE

Find more matching items within the Classic Collection. Page 46.

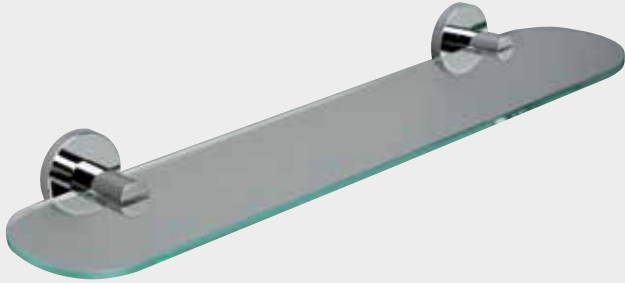

Glass Shelf L02
Clear Glass
L500 x D125 mm

£46.75



Soap Dish L04
Clear glass, Ø110 mm
H60 x D130 mm

£24.50



Lotion Bottle L34
Frosted glass
H170 x D110 mm

£33.25



Tumbler Holder L03
Clear glass
H95 x D105 mm

£24.50



Towel Ring L05
Ø160 mm

£22.50



Double Hook L23
H60 x D55 mm

£18.25



Towel Rail L06
L520 mm

£36.50



Hook L11
H60 x D55 mm

£16



Toilet Roll Holder L10
W170 x H110 mm

£22.50



Screws are included. This collection can also be fixed with our Fixing Adhesive.

We recommend that towel rails, glass shelves, mirrors, toilet brush sets, grab bars and products that carry heavy weight are screw fixed.



2 year Guarantee

Read more about the Miller Way on www.millerbathrooms.co.uk



Fixing Adhesive £16
Fixing Adhesive code no. 8798
Glue always sold separately.
Read more on millerbathrooms.co.uk

LEARN MORE

Find more matching items within the Classic Collection. Page 46.

A good morning. And an equally good night.

The morning is full of anticipation. At night it is filled by a relaxing calm. The bathroom has an important role for all - for both the large and the small family. Therefore it is important that the bathroom spreads that extra feeling of comfort that makes us feel good.

But we are all unique, with different tastes and needs and desire a bathroom that is adapted to our own personality. Freedom of choice from our wide range of bathroom furniture and accessories gives you the chance to realise your own dreams.

**New colours: Cotton Cream
and Coffee Cream**

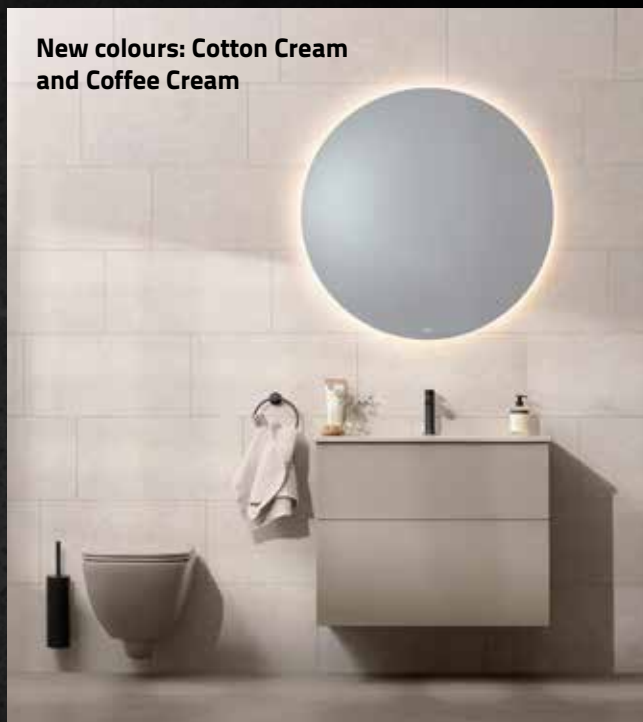

City 80

Available in 8 on-trend colours- we invite you to choose yours, built to last a lifetime. A silky smooth feel combined with a resistant matt surface make the furniture a more interesting and sustainable choice.



Kensington 96

Soft bevelled edges and beautifully framed fronts. Kensington combines classic elegant furniture with modern storage and basin possibilities. Modern beauty for a long lasting fine bathroom.

New Design for 2024



Classic 138

Back to beauty. The classic design creates a safe and warm feeling for your moments in the bathroom. Hand-worked details and rounded arches along the classic English washbasin provide a luxurious and romantic feel to everyday life.



New York 108
Smooth doors and drawers.



London 120
Framed doors and drawers.



New!
Ambient LED Mirrors **134**



Mirrors and Mirrored Cabinets **128**

- 80** City
- 96** Kensington
- 108** New York
- 120** London
- 128** Mirrors and Mirrored Cabinets
- 134** Ambient LED Mirrors
- 138** Classic
- 142** Ceramics
- 145** Taps
- 147** Handles and Knobs



New! Shapes, colours and toilets
Ceramics and Toilets **142**
Taps **145**



Material, Care and Fixing Guides
Can be found at www.millerbathrooms.co.uk

Miller
FINE BATHROOM INTERIORS

Higher standard Guaranteed

It's difficult to explain the feeling, when something feels really good inside and out. We constantly work on improving the small details which ultimately makes our bathroom furniture better.

Details that might not always be visible but after years of use the feeling becomes obvious. Miller offers a guaranteed higher standard without adding extra. Room for feelings – the Miller Way.



Open and close to feel the quality. We use only the best rails and fittings with our furniture.



Edges and fronts of both drawers and doors are of 19 mm thickness. This gives a solid and longer lasting impression.



Mirror Cabinets and Mirrors in several sizes with efficient, elegant and dimmable LED lighting.



High drawers are equipped with a retaining bar that keeps tall bottles and for instance electric tooth brushes in place.



The hinges on the double sided mirror doors are fully adjustable in all directions and soft closing.



Genuine ceramic of highest quality. See page 142 for several options of full cover basins.



Conscious choices of material give you a sustainable product with the best finish.



Fully extendable, soft closing drawers. Dividers made from solid oak. Anti-slip mats and straight insides gives you optimal storage.



Plenty of options for optimal storage.

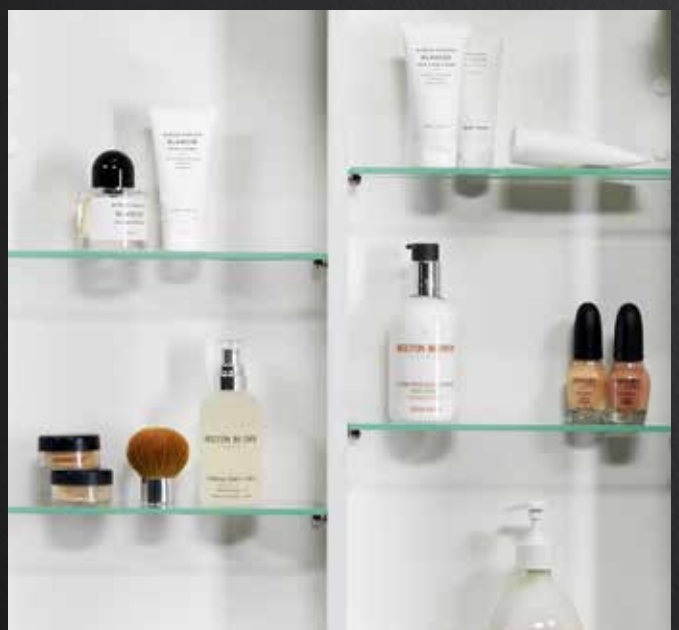

Centre divider in our bathroom cabinets gives stability and flexibility when it comes to the placement of the shelves.

Ambient LED Mirrors



Dimmable LED Lighting

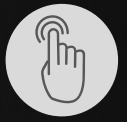

Touch-sensor

Control the dimmable mirrors with a touch sensor. Indirect, yet effective light. Choose with or without bevelled edge for a modern or classic look to enhance your bathroom.

Stepless adjustment 3000K-6000K, Demister pad and dimmable. Available in two shapes and several sizes.



Oval 50 x 100 cm **Classic Bevelled Edge**



Round 90 cm



Oval 40 x 80 cm



Round 70 cm



Oval 50 x 100 cm

Our innovative Collection City

Feel the surface- soft and smooth to the touch, fingerprint free and scratch proof. Made from an attractive, strong, high density material using the latest Nano-technology.

The surface density is the key to the colour, finish and strength of the City range - both beautiful and sustainable.

Pictures only tell half the story for City, visit one of our displaying dealers to feel the difference. See for yourself the long lasting, colour fast, smooth finish.

Available in 8 on-trend colours- we invite you to choose yours, built to last a lifetime.

Durable. Dirt and water repellent. Light resistant. Silky smooth.

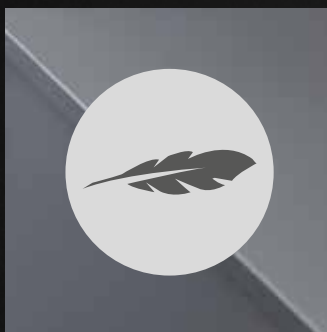

Smooth surface

Feel it – the silky-smooth surface is both nice to the touch and lovely to look at.

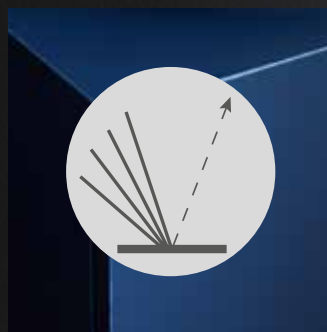

Matt surface

The matt surface reflects a minimum of light and creates a soft effect in your bathroom.

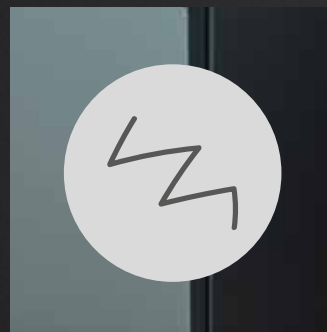

Scratch resistant material

The material surface offers the most scratch resistant surface Nano-technology can offer increased wear resistance offers longer use and sustainability

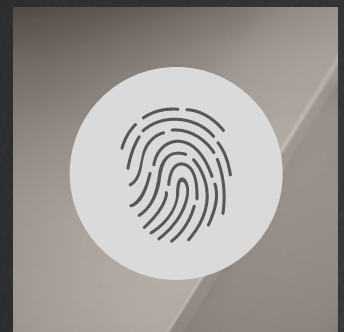

Anti-fingerprint

The special surface used is dirt and water repellent and fingerprint free.



Detail of Cotton Cream vanity with Edge colour matched basin.



Detail of Coffee Cream vanity with Edge Gloss White basin.

Powerful beauty lasts longer

Select your personal expression for a brighter morning and evening. Our featured basin choices in ceramic are tailored to our vanity units in the City, Kensington, London and New York collections.

Full cover basins in 2 shapes in several sizes: 60, 80, 100, 120 and 160 cm. Comprehensive solutions for an individual bathroom.

Three taphole and no taphole solutions on all full cover basins possible. Contact us for more information.

Colours available for Edge and Bloc Basins and Toilets



Coffee Cream



Cotton Cream

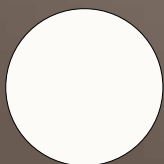

Matt White

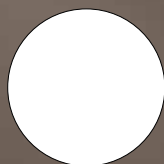

Gloss White

Three Taphole



Extended lead time on request

No Taphole



Extended leadtime on request

Edge

Beautiful full cover basin in genuine ceramic. Available in 4 on trend colours. This basin can only be placed on a vanity unit. Bottom waste is available in matching ceramic to create that uniform colour match.

Glazed overflow holes gives this basin a clean look. With a longer lead time this model can be ordered without tap hole.

~13 mm



60



80



100

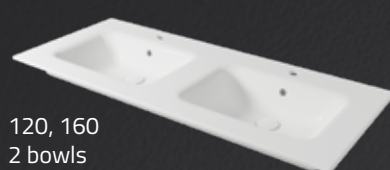

120, 160
2 bowls

Bloc

Generous full cover basin in real ceramic. Available in 4 on trend colours. This basin can be placed on a vanity unit or bolted to the wall. Bottom waste is available in matching ceramic to create that uniform colour match.

Glazed overflow holes gives this basin a clean look. With a longer lead time this model can be ordered without a tap hole.

~125 mm



60



80

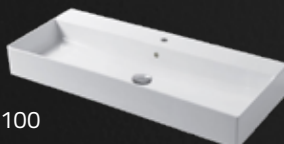

100



120
2 tap holes

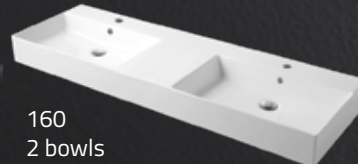

160
2 bowls



Anti bacterial glaze



Easy to clean

A brighter future starts in your bathroom

Linear LED is energy saving yet very powerful. The vertical lights reduce shadow casting and gives you the perfect mirror reflection.

The built in touch sensor enables you to control the amount of light you want – and thanks to the built in memory the Linear LED remembers your preference until next time it's turned on.

Functional, practical and beautiful – the thin LED light bars shine both forward and inward on the cabinets, making sure you have a bright time in the bathroom.

Miller



Centre divider in our bathroom cabinets gives stability and flexibility when it comes to the placement of the shelves.

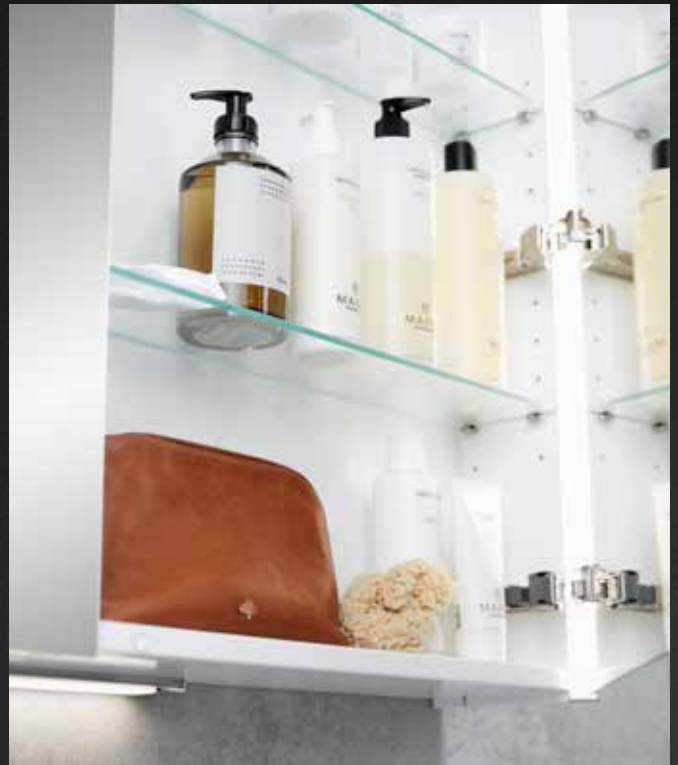

Technically powerful LED lighting creates bright lines with better colour reproduction. Perfect for makeup.



Down lighting is an option that provides an effective lighting over the basin.



The lighting is integrated into the cabinet sides and measures 16 mm x 16 mm.



Light shines both forward and inward on cabinets.



Control the brightness with a touch sensor. Linear LED remembers the last chosen setting/brightness when switched on and off.

Natural Stone Worktops

You can feel it with your fingers, and you see it with your eyes. A feeling of beauty that is sustainable for both the test of time - and your eyes desire. Choose your personal favourite from our Worktops.

Solid Worktops with a slightly bevelled edge gives a beautiful finger-tip feeling finish. Worktops can be selected to complement City, Kensington, London and New York.

Variation in appearance

Our stone worktops are made of genuine stone, which means that colour and texture vary from rock to rock. It helps you to create a natural and personal charm in your new bathroom. To make a durable surface, all of our worktops are treated.



Black Diabase

Diabase, or “black granite” as it is sometimes mistakenly called, can be seen in the black streaks in the mountains around Sweden. It is a dense and hard rock that stands up to everything. The satin black surface gives the bathroom a feeling of both luxury and pleasure.

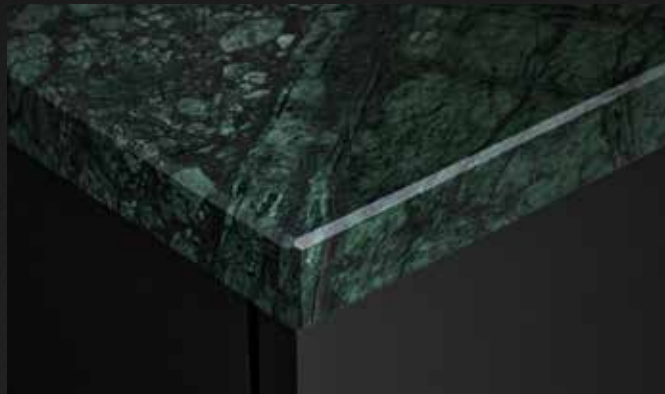

Green Marble

An alternative to the classic Carrara marble is our green marble which has recently become very popular. The deep green colour with its speckled surface creates a nice contrast to our white ceramic basins.



Limestone Jura

Limestone is a beautiful living material that fits well in the bathroom. Irregular fossil elements in a beautiful natural beige tone complements several of our bathroom furniture ranges



Grey Swedish Granite

Our beautiful grey Bohus granite comes from Bohuslän. For centuries, they have quarried the stone which is both durable and beautiful, because even if the granite is the most common rock type on earth, each stone is unique with its own grain and character.



Carrara Marble

This classic marble from Italian Carrara has been a favourite among architects and sculptors since the Roman Empire’s glory days. Charm, feel, style and classic beauty – and much more durable now thanks to our stone work tops water resistance.

CITY

40, 60, 80, 100, 120 and 160 cm

Smooth doors and drawers

Silk matt surface

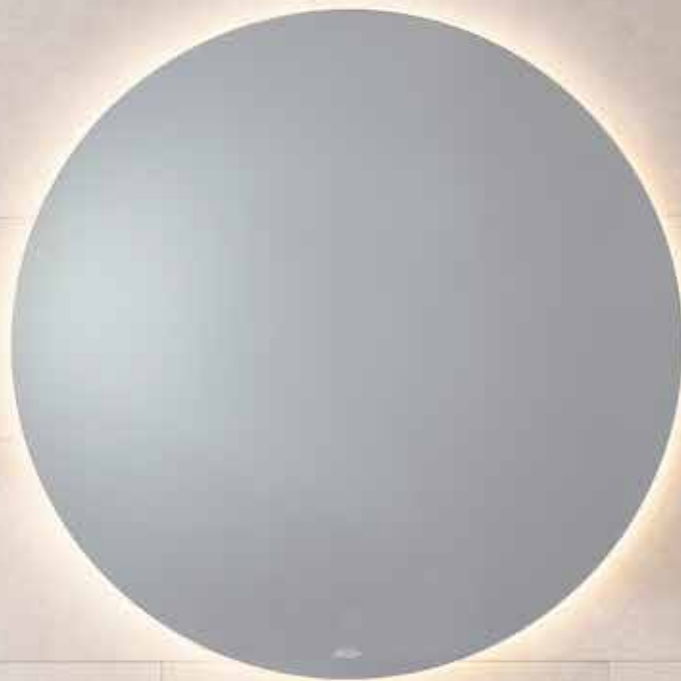

Feel the surface - soft and smooth to the touch, Fingerprint free and scratch proof. Made from an attractive, strong, high density material using the latest Nano-technology. The surface density is the key to the colour, finish and strength of the City range - both beautiful and sustainable.

Pictures only tell half the story for City, visit one of our displaying dealers to feel the difference. See for yourself the long lasting, colour fast, smooth finish.

Available in 8 on-trend colours - we invite you to choose yours, built to last a lifetime.

City 80
Ambient Mirror 90
City Vanity 80 Coffee Cream
Edge 80 basin Coffee Cream
Tap 1943B
Wall hung toilet Coffee Cream
Accessories Bond/Classic



Drawer Vanity City 80 Coffee Cream with ceramic basin Edge 80. Tap 1943B. Accessories Bond Black. Wall hung Toilet 190-WC50-54 colour matched with our City Vanity.



Drawer Vanity City 80 Coffee Cream with matching Worktop and colour matched Ceramic Basin 130-R40-54. Tap 1941C.



Ambient LED Mirror 40 x 80 cm. Door Vanity City 40 Classic White with matching worktop and Basin 135W. Accessories Miami.



Drawer Vanity 100 Midnight Blue with stone worktop in carrara marble. Basin 136W, tap 1941MP, linear LED mirror cabinet 755L-3, Down Light DL2. Tall Cabinet 795H-3.



Drawer Vanity 80 Coffee Cream with full cover basin Bloc 111-80X46-01. Matching Ceramic Waste 110-190-01. Tap 1943C.



Fully extendable drawers. City 60 drawer vanity Cotton Cream with colour matched basin Edge in Cotton Cream.



Vanity with drawers City 60 Cotton Cream with Basin Edge in Cotton Cream. Wall hung Toilet in colour matched Cotton Cream ceramic. Ambient LED Mirror 70 cm.



From the left: **Highland Green door vanity 40 784H-6T**, worktop 779-6, basin 135W, tap 1941MP, linear LED mirror 59L, knob 50886. **Midnight Blue door vanity 40 784H-3T**, worktop 779-3, basin 135W, tap 1941C, simple mirror glass 59-G+LED lighting L102, knob 93810. **Thunder Grey door vanity 40 784H-9T**, worktop 400GM, basin 174W1, tap 1940B, linear LED mirror cabinet 752HL-9, knob 50887. **Pebble Greige door vanity 40 784H-8T**, work top 400M, basin 174W1, tap 1940C, linear LED mirror 59L, knob 95042. **Charcoal Black door vanity 40 784H-4T**, worktop 400J, basin 174W1, tap 1935C, linear LED mirror cabinet 752HL-4, knob 50883.



Door Vanity City 40 Classic White with matching worktop. 135W Basin and Tap 1941C. Ambient LED Mirror 40 x 80 cm with plain glass. See more Ambient Mirrors on page 134.



Drawer Vanity 80 Charcoal Black with full cover basin 181W1, tap 1940B, linear LED mirror cabinet 754L-4 with down light DL2. Storage Cabinet 796H-4. Accessories Atlanta.

Soft closing drawers and doors. The drawers are sturdy, fully expandable and fitted with anti-slip mats. Vanity unit top drawers have compartments in solid oak that can be easily removed for cleaning. Vanity bottom drawers are fitted with an adjustable bar to stop larger items from moving.

Complete the look with our range of taps and handles to add your own finished character to the bathroom furniture.

The furniture is delivered fully assembled.

For your vanity you can choose between a full cover basin, stone worktop with integrated basin or a worktop with basin. See options below.

Colours

							
NEW Cotton Cream NCS 52010-Y30R Matching ceramic available	NEW Coffee Cream NCS 54005-Y20R Matching ceramic available	Classic White NCS 50502-Y	Midnight Blue NCS 58010-R70B	Charcoal Black NCS 58500-N	Highland Green NCS 57005-B80G	Pebble Greige NCS 55502-Y	Thunder Grey NCS 56502-B

Drawer Vanities in five ways:

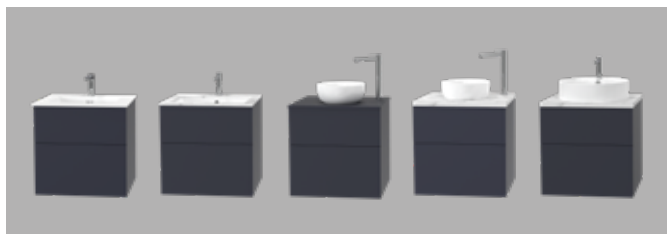

1. Drawer Vanity with full cover basin
2. Drawer Vanity with stone worktop and integrated ceramic basin
3. Drawer Vanity with wood worktop, basin and free standing tap
4. Drawer Vanity with stone worktop, basin and free standing tap
5. Drawer Vanity with worktop, basin and tap

Full Cover Ceramic Basins



Stone Worktops with Integrated Ceramic Basin

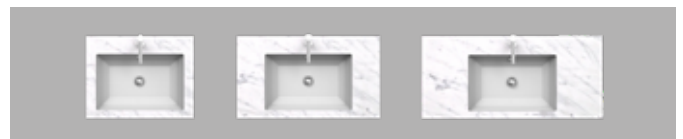

Basins for worktop, tap mounted on the basin



Basins for worktop, tap mounted on the work top



Door Vanities in two ways:

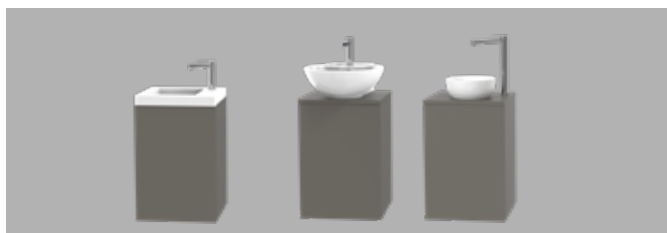

1. Door Vanity with full cover basin, only 35 cm deep
2. Door Vanity with worktop and basin

Stone Worktop 30 mm



Limestone 30 mm



Jura

City laminate Worktop 18 mm



DETAILS CITY

Symbol shows that this feature is optional. **T**



Fully extendable, soft closing drawers. Lower vanity drawers are equipped with an adjustable retaining bar that keeps bottles in place.



Top Drawer is equipped with a removable divider in solid oak.



Anti slip mats in vanity units and storage cabinet drawers.



Pad. Drawer fronts and doors have partially milled pads in rubber that stays in place.



Linear LED Mirror Cabinets in matching City 8 colours.



Endless possibilities: Highland green vanity with Green Marble stone worktop and underglued ceramic basin.



Drawers have straight insides which allows you to take advantage of the entire surface.



Bathroom Cabinets are equipped with a centre divider in wood that gives a more flexible placement of the shelves.

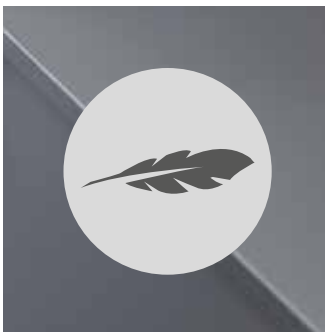

Smooth surface
Feel it – the silky-smooth surface is both nice to the touch and lovely to look at.

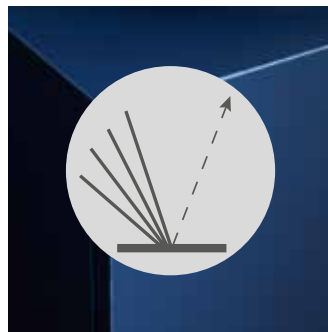

Matt surface
The matt surface reflects a minimum of light and creates a soft effect in your bathroom.

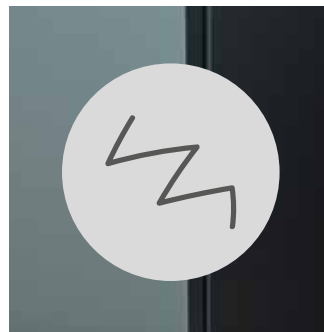

Scratch resistant material
The material surface offers the most scratch resistant surface Nano-technology can offer increased wear resistance offers longer use and sustainability.



Anti-fingerprint
The special surface used is dirt and water repellent and fingerprint free.



Our bathroom furniture has a 10 year guarantee.



Matching worktop. Thanks to the durable surface used in our City bathroom collection, we can now offer colour matched worktops.

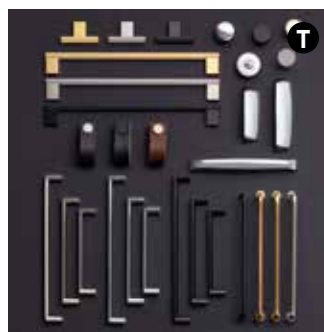

Handles and knobs. Choose between various finishes, shapes and sizes to create your personal touch. Page 147.



Taps. Choose a suitable and stylish favourite from our full range of taps. Page 145.

CITY

Vanity units are fitted with mounting rails and brackets for easy adjustment and quick installation. Drawer fronts are adjustable in all directions. Fully extending drawers with soft close mechanism.

The drawers include an anti slip mat and removable wooden dividers in solid oak.

Lower drawers in vanities are equipped with a retaining bar. Vanity units, basins, taps and handles are priced separately.

Choose between full cover basin, stone work top with integrated basin or work top with basin. All furniture is delivered fully assembled.

Read more about the Miller Way on www.millerbathrooms.co.uk

Choose colour







For Vanity colour choose colour code and replace -X



60 / 80 / 100 / 120 / 160

Vanity with full cover ceramic basin

Price separately for vanity, basin and tap.

<p>60 City</p>  <p>Size vanity W594 x H625 x D448 mm Basin size see each model</p>	<p>80 City</p>  <p>Size vanity W794 x H625 x D448 mm Basin size see each model</p>	<p>100 City</p>  <p>Size vanity W994 x H625 x D448 mm Basin size see each model</p>
<p>Vanity unit 2 drawers Choose colour 788-X £975</p> <p>Optional Push function PTM-2 £175 / for 2 drawers Handles page 147</p>	<p>Vanity unit 2 drawers Choose colour 789-X £995</p> <p>Optional Push function PTM-2 £175 / for 2 drawers Handles page 147</p>	<p>Vanity unit 2 drawers Choose colour 798-X £1195</p> <p>Optional Push function PTM-2 £175 / for 2 drawers Handles page 147</p>
<p>Basins</p> <p>Gloss white ceramic basin for 60 vanity Edge 110-60X46-01 £355 Bloc 111-60X46-01 £425</p> <p>Matt White, Cotton Cream and Coffee Cream ceramic basins available – please see page 142.</p>	<p>Gloss white ceramic basin for 80 vanity Edge 110-80X46-01 £455 Bloc 111-80X46-01 £525</p> <p>Matt White, Cotton Cream and Coffee Cream ceramic basins available – please see page 142.</p>	<p>Gloss white ceramic basin for 100 vanity Edge 110-100X46-01 £555 Bloc 111-100X46-01 £655</p> <p>Matt White, Cotton Cream and Coffee Cream ceramic basins available – please see page 142.</p>
<p>120 City</p>  <p>Size vanity W1188 x H625 x D448 mm Basin size see each model</p>	<p>160 City</p>  <p>Size vanity W1588 x H625 x D448 mm Basin size see each model</p>	<p>Full cover Ceramic Basins in 2 models and 4 colours Colour match our new City Vanity colours Cotton Cream and Coffee Cream with Ceramic basins and Toilets.</p>  <p>Edge</p>  <p>Bloc</p> <p>Images of basins in all sizes are available on page 142. Measurements are for guidance only, exact measurement should be measured on the delivered basin.</p>
<p>Vanity unit 4 drawers Choose colour 766-X £1950</p> <p>Optional Push function PTM-2 £175 / for 2 drawers Handles page 147</p>	<p>Vanity unit 2 drawers Choose colour 777-X £1990</p> <p>Optional Push function PTM-2 £175 / for 2 drawers Handles page 147</p>	
<p>Basins</p> <p>Gloss white ceramic basin for 120 vanity Edge 110-120X46-01 £755 Bloc 111-120X46-01 £855</p> <p>Matt White, Cotton Cream and Coffee Cream ceramic basins available – please see page 142.</p>	<p>Gloss white ceramic basin for 2 bowls Edge 110-160X46-01 £1255 Bloc 111-160X46-01 £1355</p> <p>Matt White, Cotton Cream and Coffee Cream ceramic basins available – please see page 142.</p>	

40

Door Vanity 40 cm with full cover ceramic basin or worktop with basin

Price separately for vanity, basin and tap.

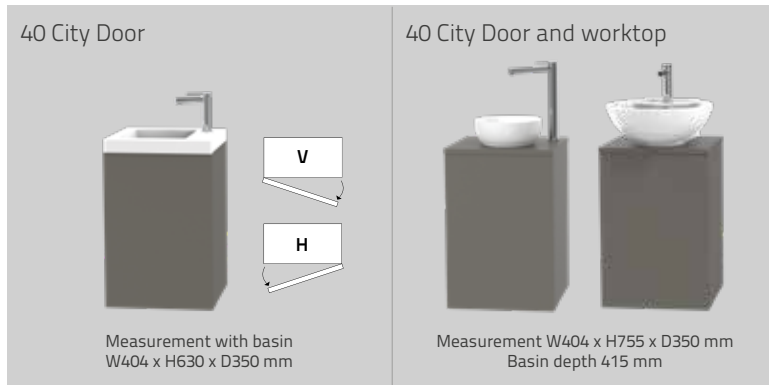

<p><i>Left hand door vanity</i> Choose colour 784V-X £545</p> <p><i>Right hand door vanity</i> Choose colour 784H-X £545</p> <p><i>Basin</i> White 165W1 £255</p> <p><i>Optional</i> Handles page 147</p>	<p><i>Left hand door vanity</i> Choose colour 784V-2T £545</p> <p><i>Right hand door vanity</i> Choose colour 784H-2T £545</p> <p><i>Basin</i> White 174W1 £210 White Ø33 135W1 £300</p> <p>Only suitable basins for 40 vanity with worktop is 174W1 and 135W1</p> <p><i>Optional</i> Handles page 147</p>
--	---

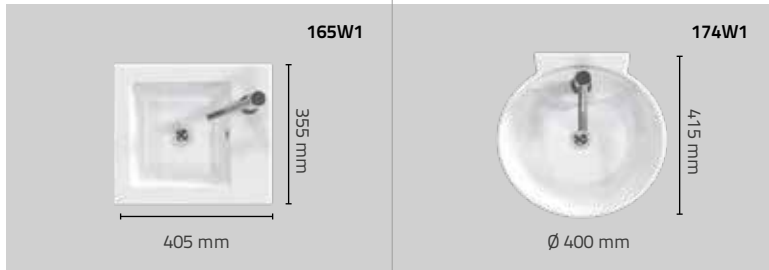

More detailed measurements on www.millerbathrooms.co.uk



Only suitable basins for 40 vanity with worktop is 174W1 and 135W1

Worktop for vanity 40 City

Stone Worktop 30 mm

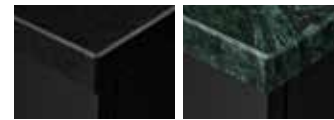
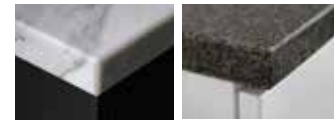

Limestone

For basin 174W1
30 mm worktop for 40 vanity

Marble	400M	£499
Grey Granite	400G	£499
Diabase	400D	£540
Green Marble	400GM	£499
Jura	400J	£499

Measurement W408 x D358 mm

For basin 135W - choose -H/-V
30 mm worktop for 40 vanity

Marble	400M-X	£499
Grey Granite	400G-X	£499
Diabase	400D-X	£540
Green Marble	400GM-X	£499
Jura	400J-X	£499

Measurement W408 x D358 mm



Worktop City 18 mm

18 mm worktop for 40 vanity
Choose colour **779-X** £125
Measurement W408 x D358 mm
Worktop delivered without waste hole.
Punching to be done by installer.

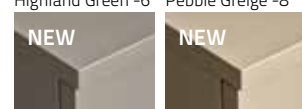

Vanity with stone work top and integrated ceramic basin

Price separately for vanity, worktop with integrated ceramic basin and tap.

<p>60 City</p>  <p>Vanity without worktop W594 x H625 x D448 mm</p>	<p>80 City</p>  <p>Vanity without worktop W794 x H625 x D448 mm</p>	<p>100 City</p>  <p>Vanity without worktop W994 x H625 x D448 mm</p>	<p>120 City</p>  <p>Vanity without worktop W1188 x H625 x D498 mm</p>
--	--	--	--

Vanity 2 drawers
Choose colour **788-XT** £975

Optional
Push function **PTM-2** £175/for 2 drawers
Handles page 147

Vanity 2 drawers
Choose colour **789-XT** £995

Optional
Push function **PTM-2** £175/for 2 drawers
Handles page 147

Vanity 2 drawers
Choose colour **798-XT** £1195

Optional
Push function **PTM-2** £175/for 2 drawers
Handles page 147

Deep Vanity 4 drawers
Choose colour **766-XTD** £1950

Optional
Push function **PTM-2** £175/for 2 drawers
Handles page 147

Choose stone worktop with integrated ceramic basin

for 60 vanity

Marble **134W/600M** £1699
Grey Granite **134W/600G** £1599
Diabase **134W/600D** £1699
Green Marble **134W/600GM** £1699
Jura **134W/600J** £1699

Price incl.integrated ceramic basin
Size worktop W595 x D455 x H30 mm

for 80 vanity

Marble **134W/800M** £1799
Grey Granite **134W/800G** £1699
Diabase **134W/800D** £1799
Green Marble **134W/800GM** £1799
Jura **134W/800J** £1799

Price incl.integrated ceramic basin
Size worktop W800 x D455 x H30 mm

for 100 vanity

Marble **134W/1000M** £1899
Grey Granite **134W/1000G** £1799
Diabase **134W/1000D** £1899
Green Marble **134W/1000GM** £1899
Jura **134W/1000J** £1899

Price incl.integrated ceramic basin
Size worktop W1000 x D455 x H30 mm

for 120 vanity

Marble **134W/1200M** POR*
Grey Granite **134W/1200G** POR*
Diabase **134W/1200D** POR*
Green Marble **134W/1200GM** POR*
Jura **134W/1200J** POR*

Price incl.integrated ceramic basins
Size worktop W1200 x D455 x H30 mm

<p>60</p>  <p>Total size work top W600 x D455 x H30 mm Ceramic W490 x D320 mm Max depth bowl 160 mm</p>	<p>80</p>  <p>Total size work top W800 x D455 x H30 mm Ceramic W490 x D320 mm Max depth bowl 160 mm</p>	<p>100</p>  <p>Total size work top W1000 x D455 x H30 mm Ceramic W490 x D320 mm Max depth bowl 160 mm</p>	<p>120</p>  <p>Total size work top W1200 x D505 x H30 mm Ceramic W490 x D320 mm Max depth bowls 160 mm</p>
--	--	---	---

<p>160 City</p>  <p>Vanity without worktop W1588 x H625 x D498 mm</p>
--

Deep Vanity 4 drawers
Choose colour **777-XTD** £1990

Optional
Push function **PTM-2** £175/for 2 drawers
Handles page 147

for 160 vanity

Marble **134W/1600M**
Grey Granite **134W/1600G**
Diabas **134W/1600D** POR*
Green Marble **134W/1600GM**
Jura **134W/1600J**

Price incl.integrated ceramic basins
Size worktop W1595 x D455 x H30 mm
*Price on request

<p>160</p>  <p>Total size work top W1595 x D505 x H30 mm Ceramic W490 x D320 mm x 2 skålar Max depth bowls 160 mm</p>
--

Stone Worktop 30 mm



Carrara Marble



Green Marble



Black Diabase



Grey Swedish Granite



Jura Limestone

Limestone 30 mm

Vanity with wood work top







Price separately for vanity, worktop with integrated ceramic basin and tap.

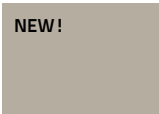
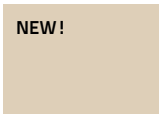
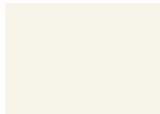

60 City	80 City	100 City	120 City
			
Vanity without worktop W594 x H625 x D448 mm Basin size see each model	Vanity without worktop W794 x H625 x D448 mm Basin size see each model	Vanity without worktop W994 x H625 x D448 mm Basin size see each model	Vanity without worktop W1188 x H625 x D448 mm Basin size see each model
<i>Vanity 2 drawers</i> Choose colour 788-XT £975	<i>Vanity 2 drawers</i> Choose colour 789-XT £995	<i>Vanity 2 drawers</i> Choose colour 798-XT £1195	<i>Deep Vanity 4 drawers</i> Choose colour 766-XTD £1950
<i>Optional</i> Push function Handles PTM-2 £175/for 2 drawers page 147	<i>Optional</i> Push function Handles PTM-2 £175/for 2 drawers page 147	<i>Optional</i> Push function Handles PTM-2 £175/for 2 drawers page 147	<i>Optional</i> Push function Handles PTM-2 £175/for 2 drawers page 147
Worktop 18 mm <i>for 60 vanity</i> Choose colour 600-X £155 <i>Size worktop W600 x D455 mm</i>	<i>for 80 vanity</i> Choose colour 800-X £195 <i>Size worktop W800 x D455 mm</i>	<i>for 100 vanity</i> Choose colour 1000-X £235 <i>Size worktop W1000 x D455 mm</i>	<i>for 120 vanity</i> Choose colour 1200-X £295 <i>Size worktop W1200 x D455 mm</i>
	<i>Vanity 4 drawers</i> Choose colour 777-XT £1990	<i>for 160 vanity</i> Choose colour 1600-2 £395	
Vanity without worktop W1588 x H625 x D448 mm Basin size see each model	<i>Optional</i> Push function Handles PTM-2 £175/for 2 drawers page 147	<i>Size worktop W1600 x D455 mm</i>	

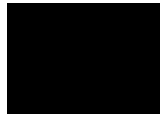
Matching laminate wood Worktop

Height 18 mm

Worktop delivered without waste hole.
Punching to be done by installer.

							
Coffee Cream -7	Cotton Cream -10	Classic White -2	Midnight Blue -3	Charcoal Black -4	Highland Green -6	Pebble Greige -8	Thunder Grey -9

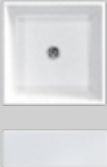
Basin for worktop, column tap mounted on the side of the basin	130-R40-01	131-R40-01	133W	132W
130-R40-01 £340 Available in more colours – see page 142				
131-R40-01 £340 Available in more colours – see page 142	Ø400 x H170 mm Max. depth bowl 150 mm	Ø400 x H165 mm Max. depth bowl 122 mm	Ø390 x H150 mm Max. depth bowl 130 mm	W390 x D390 x H130 mm Max. depth bowl 95 mm
133W £315				
132W £315				
<i>Only column taps are suitable for these washbasins: 1941C, 1941MP, 1941B.</i>				

Basin for worktop, tap mounted on the basin	116W1	171W1	173W1
116W1 £470			
171W1 £299	W500 x D495 x H180 mm	Ø460 x H180 mm	W550 x H130 x D450 mm
173W1 £299			
<i>Measurements of each basin is available on millerbathrooms.co.uk</i>			

Vanity with work top and basin, tap mounted on the basin

Price separately for vanity, basin and tap.

60 City	80 City	100 City	120 City
			
Vanity without worktop W594 x H625 x D448 mm Basin size see each model below	Vanity without worktop W794 x H625 x D448 mm Basin size see each model below	Vanity without worktop W994 x H625 x D448 mm Basin size see each model below	Vanity without worktop W1188 x H625 x D448 mm Basin size see each model below
<i>Vanity 2 drawers</i> Choose colour 788-XT £975	<i>Vanity 2 drawers</i> Choose colour 789-XT £995	<i>Vanity 2 drawers</i> Choose colour 798-XT £1195	<i>Deep Vanity 4 drawers</i> Choose colour 766-XT £1950
<i>Optional</i> Push function Handles PTM-2 £175/for 2 drawers page 147	<i>Optional</i> Push function Handles PTM-2 £175/for 2 drawers page 147	<i>Optional</i> Push function Handles PTM-2 £175/for 2 drawers page 147	<i>Optional</i> Push function Handles PTM-2 £175/for 2 drawers page 147
Worktop <i>Worktop for 60 vanity</i> Grey Granite 600G £620 Marble 600M £620 Diabase 600D £720 Green Marble 600GM £620 Jura 600J £620 <i>Size worktop W595 x D455 mm</i> <i>For height see each work top</i>	<i>Worktop for 80 vanity</i> Grey Granite 800G £720 Marble 800M £720 Diabase 800D £825 Green Marble 800GM £720 Jura 800J £720 <i>Size worktop W795 x D455 mm</i> <i>For height see each work top</i>	<i>Worktop for 100 vanity</i> Grey Granite 1000G £825 Marble 1000M £825 Diabase 1000D £979 Green Marble 1000GM £825 Jura 1000J £825 <i>Size worktop W995 x D455 mm</i> <i>For height see each work top</i>	<i>Worktop for 120 vanity</i> Grey Granite 1200G £1029 Marble 1200M £1029 Diabase 1200D £1239 Green Marble 1200GM £1029 Jura 1200J £1029 <i>Size worktop W1595 x D455 mm</i> <i>For height see each work top</i>



Deep Vanity 4 drawers
White **777-XT** £1990

Optional
Push function
Handles **PTM-2** £175/for 2 drawers
page 147

Worktop for 160 vanity
Marble **1600M**
Grey Granite **1600G**
Diabas **1600D**
Green Marble **1600GM**
Jura **1600J**

Price on request

Size worktop W1595 x D455 mm
For height see each work top

Stone worktop 30 mm

Up to 6 weeks delivery



Grey Swedish Granite



Carrara Marble



Black Diabase



Green Marble



Jura

Limestone

Up to 6 weeks delivery

Waste and tap hole position

The worktops are pre-cut with tap hole and waste holes as per diagram.

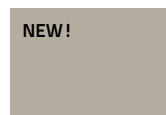
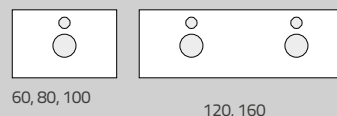

Coffee Cream -7

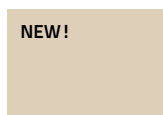

Cotton Cream -10

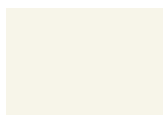

Classic White -2



Midnight Blue -3

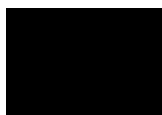

Charcoal Black -4



Highland Green -6



Pebble Greige -8



Thunder Grey -9

Basin for worktop, tap mounted on the basin

116W1 £470
171W1 £299
173W1 £299

116W1



W500 x D495 x H180 mm

171W1



Ø460 x H180 mm

173W1







W550 x H130 x D450 mm

Measurements of each basin is available on millerbathrooms.co.uk

Vanity with work top and basin, column tap mounted on the worktop

Price separately for vanity, basin and tap.

60 City	80 City	100 City	120 City
			
Vanity without worktop W594 x H625 x D448 mm Basin size see each model below	Vanity without worktop W794 x H625 x D448 mm Basin size see each model below	Vanity without worktop W994 x H625 x D448 mm Basin size see each model below	Vanity without worktop W1188 x H625 x D448 mm Basin size see each model below
Vanity 2 drawers Choose colour 788-XT £975	Vanity 2 drawers Choose colour 789-XT £995	Vanity 2 drawers Choose colour 798-XT £1195	Deep Vanity 4 drawers Choose colour 766-XT £1950
Optional Push function PTM-2 £175/for 2 drawers Handles page 147	Optional Push function PTM-2 £175/for 2 drawers Handles page 147	Optional Push function PTM-2 £175/for 2 drawers Handles page 147	Optional Push function PTM-2 £175/for 2 drawers Handles page 147
Worktop <i>Worktop for 60 vanity</i> Grey Granite 600G-X £620 Marble 600M-X £620 Diabase 600D-X £720 Green Marble 600GM-X £620 Jura 600J-X £620 <i>Size worktop W595 x D455 mm</i> <i>For height see each work top</i>	<i>Worktop for 80 vanity</i> Grey Granite 800G-X £720 Marble 800M-X £720 Diabase 800D-X £825 Green Marble 800GM-X £720 Jura 800J-X £720 <i>Size worktop W795 x D455 mm</i> <i>For height see each work top</i>	<i>Worktop for 100 vanity</i> Grey Granite 1000G-X £825 Marble 1000M-X £825 Diabase 1000D-X £979 Green Marble 1000GM-X £825 Jura 1000J-X £825 <i>Size worktop W995 x D455 mm</i> <i>For height see each work top</i>	<i>Worktop for 120 vanity</i> Grey Granite 1200G-X £1029 Marble 1200M-X £1029 Diabase 1200D-X £1029 Green Marble 1200GM-X £1239 Jura 1200J-X £1029 <i>Size worktop W1595 x D455 mm</i> <i>For height see each work top</i>



NOTE -X, choose hole pattern, ex. 600M-V is a 60 cm marble worktop with tap hole to the left of the basin
ex. 600D-H is a 60 cm diabase worktop with tap hole to the right of the basin

Deep Vanity 4 drawers White 777-XT £1990	Worktop for 160 vanity Marble 1600M-X Grey Granite 1600G-X Diabas 1600D-X Green Marble 1600GM-X Jura 1600J-X	Price on request
Optional Push function PTM-2 £175/for 2 drawers Handles page 147	<i>Size worktop W1595 x D455 mm</i> <i>For height see each work top</i>	

Waste and tap hole position

Note The tap is placed to the right or to the left of the basin on the worktop. -X, choose hole pattern example 600M-V is a 60 cm Marble worktop with tap hole to the left of the basin.

The worktops are pre-cut with tap hole and waste holes as per diagram.



to the right **-H**

add -H after the worktop code no example: 600M-H



to the left **-V**

add -V after the worktop code no example: 600M-V



120/160 left + right
example: 1600M-HV



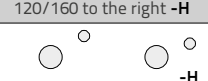

120/160 to the left **-V**
example: 1600M-V



120/160 to the right **-H**
example: 1600M-H

Basin for worktop, column tap mounted on the side of the basin

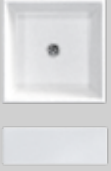

130-R40-01 £340 Available in more colours – see page 142	131-R40-01 £340 Available in more colours – see page 142	133W £315	132W £315
			
Ø400 x H170 mm Max. depth bowl 150 mm	Ø400 x H165 mm Max. depth bowl 122 mm	Ø390 x H150 mm Max. depth bowl 130 mm	W390 x D390 x H130 mm Max. depth bowl 95 mm

Only column taps are suitable for these washbasins: 1941C, 1941MP, 1941B.

STORAGE CITY

Fitted with mounting rails and brackets for easy adjustment and quick installation. Soft closing doors and drawers. V stands for left hand door and H stands for right hand door (see sketch). All furniture is delivered fully assembled.

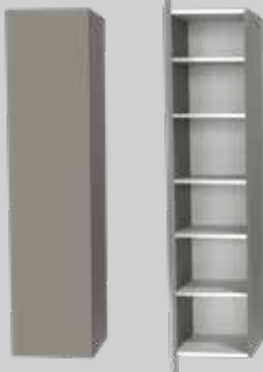
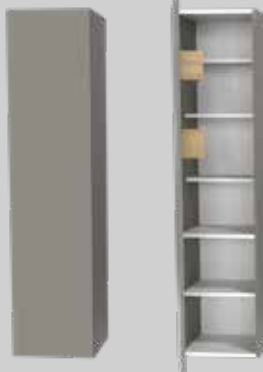
Read more about the Miller Way on www.millerbathrooms.co.uk

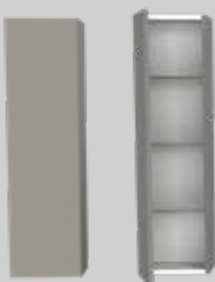
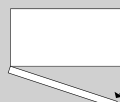
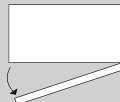
<p>Tall Cabinet</p> <p>1 fixed and 4 adjustable wood shelves</p>  <p>W404 x H1690 x D380 mm</p> <p>Left hand door Choose colour 793V-X £1195</p> <p>Right hand door Choose colour 793H-X £1195</p> <p>Optional Handle page 147</p>	<p>Tall Cabinet with door storage</p> <p>1 fixed and 4 adjustable wood shelves Door storage 2 boxes in solid oak.</p>  <p>W404 x H1690 x D380 mm</p> <p>Left hand door Choose colour 794V-X £1395</p> <p>Right hand door Choose colour 794H-X £1395</p> <p>Optional Handle page 147</p>	<p>Tall Cabinet with door storage and 2 drawers</p> <p>1 fixed and 4 adjustable wood shelves Door storage 2 boxes in solid oak and 2 oak drawers.</p>  <p>W404 x H1690 x D380 mm</p> <p>Left hand door Choose colour 795V-X £1950</p> <p>Right hand door Choose colour 795H-X £1950</p> <p>Optional Handle page 147</p>
<p>Tall Cabinet with 2 drawers</p> <p>1 fixed and 3 adjustable wood shelves, 2 oak drawers.</p>  <p>W404 x H1690 x D380 mm</p> <p>Left hand door Choose colour 792V-X £1545</p> <p>Right hand door Choose colour 792H-X £1545</p> <p>Optional Handle page 147</p>	<p>Storage Cabinet</p> <p>3 adjustable glass shelves</p>  <p>W304 x H1111 x D255 mm</p> <p>Left hand door Choose colour 796V-X £695</p> <p>Right hand door Choose colour 796H-X £695</p> <p>Optional Handle page 147</p>	<p>Right or left hand door?</p>  <p>V = Left hand door</p>  <p>H = Right hand door</p> <p>Choose between a right or left hand door on your storage cabinet. See sketch above. V is for left hand door and H is right hand door in the code no.</p> <p>We do not offer "Push Function" for our storage cabinets.</p>

Colours

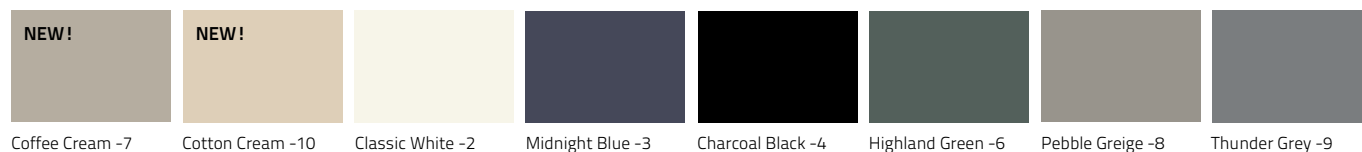

Tall Cabinet 40 cm
795H-3
Midnight Blue



Tall Cabinet 40 cm
793H-9
Pebble Greige



Storage Cabinet 30 cm
796H-6
Highland Green

OPTIONAL STORAGE

Handle



Handles and knobs. Choose between various finishes, shapes and sizes to create your personal touch. See page 147.

MIRROR CABINET LINEAR LED CITY

Integrated dimmable light with touch sensor. Technically powerful LED light creates illuminated lines with better colour reproduction. Perfect for makeup. Linear LED cabinets are dimmed via the touch sensor on the mirror cabinet, not via dimmers on the wall. IP44 rated.

Fitted with mounting rails and brackets for adjustable & quick installation. Soft closing double sided mirror doors. Choose left or right hand door for the 40 bathroom cabinet, see illustration below. All furniture is delivered fully assembled.

Read more about the Miller Way on www.millerbathrooms.co.uk

40 / 60 / 80 / 100

Colours



Coffee Cream -7

Cotton Cream -10

Classic White -2

Midnight Blue -3

Charcoal Black -4

Highland Green -6

Pebble Greige -8

Thunder Grey -9

40 City Linear LED



W404 x H700 x D145 mm

2 x glass shelves, IP44

Left hand door

Choose colour **752VL-X** £675

Right hand door

Choose colour **752HL-X** £675

Optional

Down Light **DL2** £79

2 extra glass shelves **54-190** £21

60 City Linear LED

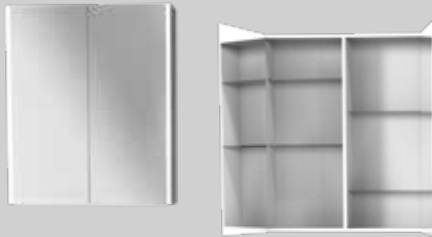

W594 x H700 x D145 mm

4 x glass shelves, centre wood divider, IP44

Choose colour **753L-X** £845

Optional

Down Light **DL2** £79

2 extra glass shelves **53-190** £19

80 City Linear LED

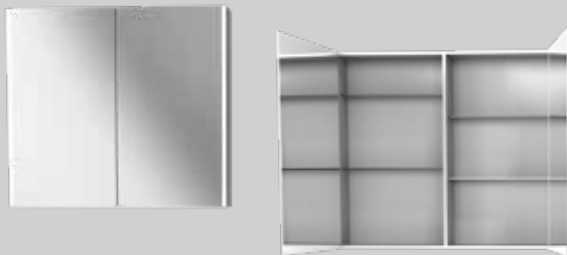

W794 x H700 x D145 mm

4 x glass shelves, centre wood divider, IP44

Choose colour **754L-X** £925

Optional

Down Light **DL2** £79

2 extra glass shelves **54-190** £21

100 City Linear LED

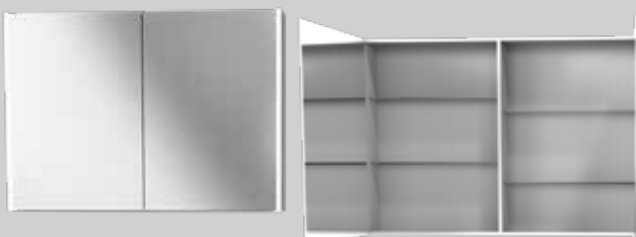

W994 x H700 x D145 mm

4 x glass shelves, centre wood divider, IP44

Choose colour **755L-X** £975

Optional

Down Light **DL2** £79

2 extra glass shelves **55-190** £23

The inside of all cabinets is white.

MIRROR CABINET LINEAR LED CITY

Details



Centre divider in wood for stability and a more flexible placement of the shelves.



Control the brightness with a touch sensor. Our new Bathroom Cabinet memorises the latest desired brightness when switched on and off.



The lighting is integrated in the sides of the bathroom cabinets and measures 16 mm x 16 mm. Matching Down Light DL2.



Light shines both forward and inward on cabinets.

OPTIONAL

Down Light Linear LED



Chrome **DL2** £79
Chrome finish. White neutral sheen. IP44.
Dimmable with Linear LED Mirror Cabinet.
1 down light fits cabinet
40, 60, 80 and 100.

Extra Glass Shelves



For right size please see optional under
each bathroom cabinet.
Shelf brackets are included.

Can only be combined with Linear LED
Mirror Cabinet, Linear LED Mirrors and
Linead LED Top Light L102.

KENSINGTON

60, 80, 100 cm

Decorative framed mirror doors and drawers

Floor standing or Wall hung



New times need new elegance - as well as a splash of classical beauty. Our bathroom collection Kensington unites timeless beauty with a new era of design. The slightly bevelled sides, the beautiful well-designed frame mirrors, the care in every detail and the beautiful finish fills your bathroom with new, beautiful feelings.

Choose from a sleek rustic floor standing vanity with plinth or make use of the space in your bathroom with a beautiful wall-mounted vanity. Enjoy the choice between fashion colours white or dark grey or combine. Kensington surprises with plenty of space for both style and feel.

Kensington 80
Mirror Cabinet 54L-9
Decorative top for Mirror Cabinet 06-454-9
Down Light DL2
Vanity 489-9
Worktop with Basin 134W/800M
Tap 1940C
Storage 495V-9
WC 390W, Seat 347-4
Accessories Stockholm/Classic



Stone worktop with integrated basin. Available in 60, 80 and 100 cm. Choose between Italian Carrara Marble, black Diabase and grey Granite.



The basin is recessed in the stone work top which gives a 10 mm thin stone edge on the inside even though the stone worktops are 30 mm.



Kensington vanity units and storage units are available as floor standing with a plinth for a solid built impression. Alternatively as a wall hung option.



With different handles you can create your personal touch. Above is knob 3103C Ø30 mm.



The wall hung vanities feature a decorative bottom plate.



Wall hung vanity 60 with a Carrara Marble worktop.



A storage cabinet that gives more room and takes less space.



Adjustable wooden shelves in combination with drawers for optimal storage.



The basin is recessed in the Stone Worktop which gives a 10 mm thin stone edge on the inside even though the stone worktops are 30 mm.



Floor standing vanity 80 with linear led 80 Mirror Cabinet.



The plinth gives a solid built feel. The front is removable to ease cleaning under the vanity.

Decorative framed mirror doors and drawers. Choose between floor standing or wall hung. Available in white and dark grey.

Soft closing drawers and doors. The drawers are sturdy, fully expandable and fitted with anti-slip mats. Vanity bottom drawers are fitted with an adjustable bar to stop larger items from moving.

For your vanity you can choose between a full cover basin, stone worktop with integrated basin or a worktop with basin. See options below.

Complete the look with our range of taps and handles to add your own finished character to the bathroom furniture.

The furniture is delivered fully assembled.

Colour



White

Dark Grey

Drawer Vanities in four ways:



1. Drawer Vanity with full cover basin
2. Drawer Vanity with stone worktop and integrated ceramic basin
3. Drawer Vanity with worktop, basin and tap mounted on the worktop
4. Drawer Vanity with worktop and basin with tap mounted on the basin

Full Cover Ceramic Basins in two shapes

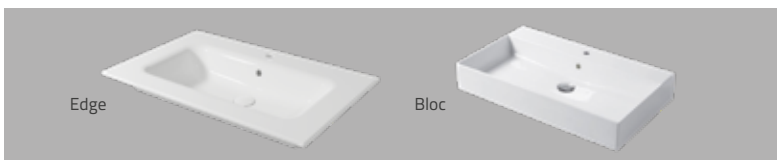

Stone Worktop with integrated ceramic basin

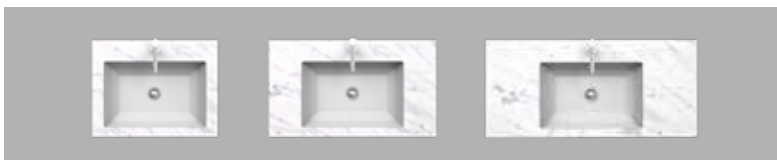

Basin for worktop, tap mounted on the work top



Basins for worktop, tap mounted on the basin



Stone Work top

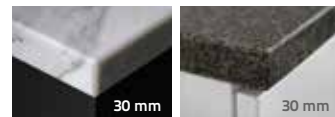

Carrara Marble

Grey Granite

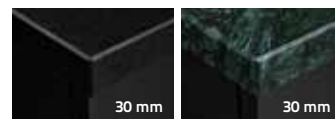

Black Diabase

Green Marble

Limestone



Jura



Our bathroom furniture has a 10 year guarantee

DETAILS KENSINGTON

Symbol shows that this feature is optional. **T**



Fully extendable, soft closing drawers. Lower vanity drawers are equipped with an adjustable retaining bar that keeps bottles in place.



Top Drawer is equipped with a removable divider in solid oak. **Anti slip mats** in vanity units and storage cabinet drawers.



Wall hung furniture give a more modern look. Wooden bottom plate frames the furniture.



The plinth gives the furniture a solid built feeling. The front is removable for easy cleaning. Choose **floor standing** vanity with plinth or **wall hung** vanity.



A variety of **basins** available. Image shows Edge 80 in Gloss White with colour matched ceramic Waste.



Practical storage solutions for you to choose from.



Drawers have straight insides which allows you to take advantage of the entire surface.



Bathroom Cabinet 60, 80, 100, 120 are equipped with a centre divider in wood that gives a more flexible placement of the glass shelves.



Dimmable Energy efficient top light with a neutral white light. Combine with matching down light. **Option code no. L102**

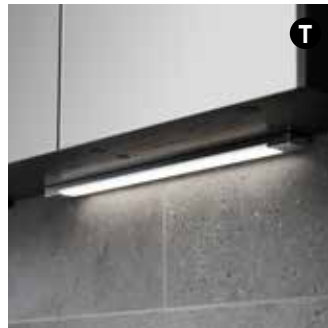

LED Down light that gives a white natural shine. **Option code no. DL2**



Linear LED Bathroom Cabinet dimmable lit bars. Energy efficient LED lighting with a white neutral sheen. Complete with **matching Down Light code no. DL2**.



Sides are slightly beveled. Fronts are recessed.



Decorative **framed mirror doors** and fronts.



Integrated ceramic basin is one of the options for Kensington vanities.

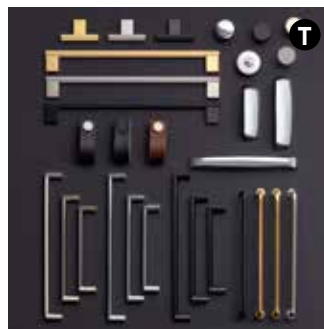

Handles and knobs. Choose between various finishes, shapes and sizes to create your personal touch. Page 147.

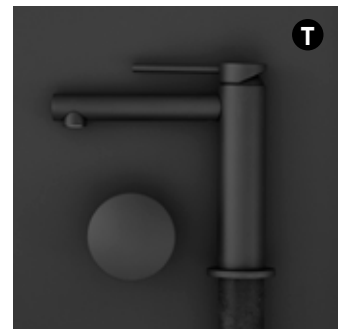

Taps. You can easily find a suitable and stylish favourite among our taps. Page 145.

KENSINGTON

Vanity units are fitted with mounting rails and brackets for easy adjustment and quick installation. Drawer fronts are adjustable in all directions. Fully extending drawers with soft close mechanism.

The drawers include an anti slip mat and removable wooden dividers in solid oak.

Lower drawers in vanities are equipped with a retaining bar. Vanity Units, basins, taps and handles are priced separately.

Choose between full cover basin, stone worktop with integrated basin or worktop with basin. All furniture is delivered fully assembled.

Read more about the Miller Way on www.millerbathrooms.co.uk

Colour

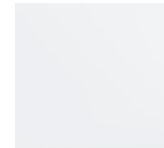

White



Dark Grey

60 / 80 / 100

Vanity with full cover ceramic basin

Size 60, 80, 100 - floorstanding or wall hung - price separately for vanity, basin and tap.

60 floorstanding	80 floorstanding	100 floorstanding																		
<p>Size vanity W610 x H802 x D458 mm Basin size see each model below</p>	<p>Size vanity W810 x H802 x D458 mm Basin size see each model below</p>	<p>Size vanity W1010 x H802 x D458 mm Basin size see each model below</p>																		
<p>Vanity floorstanding 2 drawers</p> <table border="0"> <tr> <td>White</td> <td>488-2</td> <td>£1025</td> </tr> <tr> <td>Dark Grey</td> <td>488-9</td> <td>£1025</td> </tr> </table> <p>Optional Handles page 147</p>	White	488-2	£1025	Dark Grey	488-9	£1025	<p>Vanity floorstanding 2 drawers</p> <table border="0"> <tr> <td>White</td> <td>489-2</td> <td>£1045</td> </tr> <tr> <td>Dark Grey</td> <td>489-9</td> <td>£1045</td> </tr> </table> <p>Optional Handles page 147</p>	White	489-2	£1045	Dark Grey	489-9	£1045	<p>Vanity floorstanding 2 drawers</p> <table border="0"> <tr> <td>White</td> <td>498-2</td> <td>£1150</td> </tr> <tr> <td>Dark Grey</td> <td>498-9</td> <td>£1150</td> </tr> </table> <p>Optional Handles page 147</p>	White	498-2	£1150	Dark Grey	498-9	£1150
White	488-2	£1025																		
Dark Grey	488-9	£1025																		
White	489-2	£1045																		
Dark Grey	489-9	£1045																		
White	498-2	£1150																		
Dark Grey	498-9	£1150																		
60 wall hung	80 wall hung	100 wall hung																		
<p>Size vanity W610 x H644 x D458 mm Basin size see each model below</p>	<p>Size vanity W810 x H644 x D458 mm Basin size see each model below</p>	<p>Size vanity W1010 x H644 x D458 mm Basin size see each model below</p>																		
<p>Vanity wall hung 2 drawers</p> <table border="0"> <tr> <td>White</td> <td>1488-2</td> <td>£775</td> </tr> <tr> <td>Dark Grey</td> <td>1488-9</td> <td>£775</td> </tr> </table> <p>Optional Handles page 147</p>	White	1488-2	£775	Dark Grey	1488-9	£775	<p>Vanity wall hung 2 drawers</p> <table border="0"> <tr> <td>White</td> <td>1489-2</td> <td>£835</td> </tr> <tr> <td>Dark Grey</td> <td>1489-9</td> <td>£835</td> </tr> </table> <p>Optional Handles page 147</p>	White	1489-2	£835	Dark Grey	1489-9	£835	<p>Vanity wall hung 2 drawers</p> <table border="0"> <tr> <td>White</td> <td>1498-2</td> <td>£940</td> </tr> <tr> <td>Dark Grey</td> <td>1498-9</td> <td>£940</td> </tr> </table> <p>Optional Handles page 147</p>	White	1498-2	£940	Dark Grey	1498-9	£940
White	1488-2	£775																		
Dark Grey	1488-9	£775																		
White	1489-2	£835																		
Dark Grey	1489-9	£835																		
White	1498-2	£940																		
Dark Grey	1498-9	£940																		
<p>Basins</p> <p>Gloss white ceramic basin for 60 vanity</p> <table border="0"> <tr> <td>Edge</td> <td>110-60X46-01</td> <td>£355</td> </tr> <tr> <td>Bloc</td> <td>111-60X46-01</td> <td>£425</td> </tr> </table> <p>For basins in other colours please see page 142</p>	Edge	110-60X46-01	£355	Bloc	111-60X46-01	£425	<p>Gloss white ceramic basin for 80 vanity</p> <table border="0"> <tr> <td>Edge</td> <td>110-80X46-01</td> <td>£455</td> </tr> <tr> <td>Bloc</td> <td>111-80X46-01</td> <td>£525</td> </tr> </table> <p>For basins in other colours please see page 142</p>	Edge	110-80X46-01	£455	Bloc	111-80X46-01	£525	<p>Gloss white ceramic basin for 100 vanity</p> <table border="0"> <tr> <td>Edge</td> <td>110-100X46-01</td> <td>£555</td> </tr> <tr> <td>Bloc</td> <td>111-100X46-01</td> <td>£655</td> </tr> </table> <p>For basins in other colours please see page 142</p>	Edge	110-100X46-01	£555	Bloc	111-100X46-01	£655
Edge	110-60X46-01	£355																		
Bloc	111-60X46-01	£425																		
Edge	110-80X46-01	£455																		
Bloc	111-80X46-01	£525																		
Edge	110-100X46-01	£555																		
Bloc	111-100X46-01	£655																		

Full cover Ceramic Basins



2 models and 4 colours

Colour match our full cover Basins with floor standing or wall hung Toilets.

Colour matched ceramic Waste available as an option. Please see images of basins in all sizes on page 142.

Edge



Bloc



Measurements are for guidance only, exact measurement should be measured on the delivered basin.

Vanity with stone worktop and integrated ceramic basin

Size 60, 80, 100 - floorstanding or wall hung - price separately for vanity, worktop with integrated ceramic basin and tap



Size vanity without worktop W610 x H802 x D458 mm

Size vanity without worktop W810 x H802 x D458 mm

Size vanity without worktop W1010 x H802 x D458 mm

Vanity floorstanding 2 drawers
 White **488-2T** £1025
 Dark Grey **488-9T** £1025
 Optional
 Handles page 147

Vanity floorstanding 2 drawers
 White **489-2T** £1045
 Dark Grey **489-9T** £1045
 Optional
 Handles page 147

Vanity floorstanding 2 drawers
 White **498-2T** £1150
 Dark Grey **498-9T** £1150
 Optional
 Handles page 147



Size vanity without worktop W610 x H644 x D458 mm

Size vanity without worktop W810 x H644 x D458 mm

Size vanity without worktop W1010 x H644 x D458 mm

Vanity wall hung 2 drawers
 White **1488-2T** £775
 Dark Grey **1488-9T** £775
 Optional
 Handles page 147

Vanity wall hung 2 drawers
 White **1489-2T** £835
 Dark Grey **1489-9T** £835
 Optional
 Handles page 147

Vanity wall hung 2 drawers
 White **1498-2T** £940
 Dark Grey **1498-9T** £940
 Optional
 Handles page 147

Choose stone worktop with integrated ceramic basin

Worktop for 60 vanity
 Marble **134W/600M** £1699
 Grey Granite **134W/600G** £1599
 Diabase **134W/600D** £1699
 Green Marble **134W/600GM** £1699
 Jura **134W/600J** £1699
 Price incl.integrated ceramic basin
 Size worktop W595 x D455 x H30 mm

Worktop for 80 vanity
 Marble **134W/800M** £1799
 Grey Granite **134W/800G** £1699
 Diabase **134W/800D** £1799
 Green Marble **134W/800GM** £1799
 Jura **134W/800J** £1799
 Price incl.integrated ceramic basin
 Size worktop W795 x D455 x H30 mm

Worktop for 100 vanity
 Marble **134W/1000M** £1899
 Grey Granite **134W/1000G** £1799
 Diabase **134W/1000D** £1899
 Green Marble **134W/1000GM** £1899
 Jura **134W/1000J** £1899
 Price incl.integrated ceramic basin
 Size worktop W995 x D455 x H30 mm



Total size work top W595 x D455 x H30 mm
 Ceramic W490 x D320 mm. Max depth bowl 160 mm

Total size work top W795 x D455 x H30 mm
 Ceramic W490 x D320 mm. Max depth bowl 160 mm

Total size work top W995 x D455 x H30 mm
 Ceramic W490 x D320 mm. Max depth bowl 160 mm

Genuine stone worktop 30 mm with integrated ceramic basin

Up to 6 weeks delivery



Carrara Marble



Black Diabase

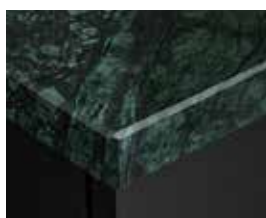

Green Marble



Limestone Jura



Grey Swedish Granite

Vanity with work top and basin, tap mounted on the basin

Size 60, 80, 100 - floorstanding or wall hung - price separately for vanity, basin and tap.



60 floorstanding
 Vanity unit floorstanding 2 drawers
 White **488-2T** £1025
 Dark Grey **488-9T** £1025
 Optional Handles page 147

80 floorstanding
 Vanity unit floorstanding 2 drawers
 White **489-2T** £1045
 Dark Grey **489-9T** £1045
 Optional Handles page 147

100 floorstanding
 Vanity unit floorstanding 2 drawers
 White **498-2T** £1150
 Dark Grey **498-9T** £1150
 Optional Handles page 147



60 wall hung
 Vanity unit wall hung 2 drawers
 White **1488-2T** £775
 Dark Grey **1488-9T** £775
 Optional Handles page 147

80 wall hung
 Vanity unit wall hung 2 drawers
 White **1489-2T** £835
 Dark Grey **1489-9T** £835
 Optional Handles page 147

100 wall hung
 Vanity unit wall hung 2 drawers
 White **1498-2T** £940
 Dark Grey **1498-9T** £940
 Optional Handles page 147

Worktop

Worktop for 60 vanity
 Marble **600M** £620
 Granite **600G** £620
 Diabase **600D** £720
 Green Marble **600GM** £620
 Jura **600J** £620
 Size worktop W595 x D455 mm
 For height see each work top

Worktop for 80 vanity
 Marble **800M** £720
 Granite **800G** £720
 Diabase **800D** £825
 Green Marble **800GM** £720
 Jura **800J** £720
 Size worktop W795 x D455 mm
 For height see each work top

Worktop for 100 vanity
 Marble **1000M** £825
 Granite **1000G** £825
 Diabase **1000D** £979
 Green Marble **1000GM** £825
 Jura **1000J** £825
 Size worktop W995 x D455 mm
 For height see each work top

Genuine stone worktop 30 mm Up to 6 weeks delivery



Grey Granite Height 30 mm Carrara Marble Height 30 mm Black Diabase Height 30 mm Green Marble Height 30 mm Limestone - Jura Height 30 mm

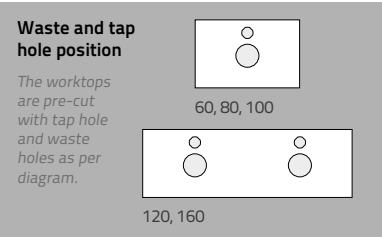

Ceramic basins in four shapes









116W1 £470
171W1 £299
173W1 £299

For more information on each basin please see page 142.

116W1 **171W1** **173W1**
 W500 x D495 x H180 mm Ø460 x H130 mm W550 x H130 x D450 mm

Vanity with work top and basin, column tap mounted on the worktop

Size 60, 80, 100 - floorstanding or wall hung - price separately for vanity, basin and tap.

60 floorstanding	80 floorstanding	100 floorstanding
 <p>Size vanity W610 x H802 x D458 mm Basin size see each model below</p>	 <p>Size vanity W810 x H802 x D458 mm Basin size see each model below</p>	 <p>Size vanity W1010 x H802 x D458 mm Basin size see each model below</p>
<p><i>Vanity unit floorstanding 2 drawers</i></p> <p>White 488-2T £1025 Dark Grey 488-9T £1025 <i>Optional</i> Handles page 147</p>	<p><i>Vanity unit floorstanding 2 drawers</i></p> <p>White 489-2T £1045 Dark Grey 489-9T £1045 <i>Optional</i> Handles page 147</p>	<p><i>Vanity unit floorstanding 2 drawers</i></p> <p>White 498-2T £1150 Dark Grey 498-9T £1150 <i>Optional</i> Handles page 147</p>
60 wall hung	80 wall hung	100 wall hung
 <p>Size vanity W610 x H802 x D458 mm Basin size see each model below</p>	 <p>Size vanity W810 x H802 x D458 mm Basin size see each model below</p>	 <p>Size vanity W1010 x H802 x D458 mm Basin size see each model below</p>
<p><i>Vanity unit wall hung 2 drawers</i></p> <p>White 1488-2T £775 Dark Grey 1488-9T £775 <i>Optional</i> Handles page 147</p>	<p><i>Vanity unit wall hung 2 drawers</i></p> <p>White 1489-2T £835 Dark Grey 1489-9T £835 <i>Optional</i> Handles page 147</p>	<p><i>Vanity unit wall hung 2 drawers</i></p> <p>White 1498-2T £940 Dark Grey 1498-9T £940 <i>Optional</i> Handles page 147</p>
<p>Worktop</p> <p><i>Worktop for 60 vanity</i></p> <p>Marble 600M-X £620 Granite 600G-X £620 Diabase 600D-X £720 Green Marble 600GM-X £620 Jura 600J-X £620 <i>Size worktop W595 x D455 mm</i> <i>For height see each worktop</i></p>	<p><i>Worktop for 80 vanity</i></p> <p>Marble 800M-X £720 Granite 800G-X £720 Diabase 800D-X £825 Green Marble 800GM-X £720 Jura 800J-X £720 <i>Size worktop W795 x D455 mm</i> <i>For height see each worktop</i></p>	<p><i>Worktop for 100 vanity</i></p> <p>Marble 1000M-X £825 Granite 1000G-X £825 Diabase 1000D-X £979 Green Marble 1000GM-X £825 Jura 1000J-X £825 <i>Size worktop W995 x D455 mm</i> <i>For height see each worktop</i></p>

NOTE -X, choose hole pattern, ex. 600M-V is a 60 cm marble worktop with tap hole to the left of the basin
ex. 600D-H is a 60 cm diabase worktop with tap hole to the right of the basin

Waste and tap hole position

The tap is placed to the right or to the left of the basin on the worktop.

to the right -H



add a -H after the worktop code no. ie: 600M-H







The worktops are pre-cut with tap hole and waste holes as per diagram.

to the left -V



add a -H after the worktop code no. ie: 600M-H

Ceramic basins

Basin for worktop, column tap mounted on the side of the basin	130-R40-01	131-R40-01	133W	132W
<p>130-R40-01 £340 Available in more colours - see page 142. 131-R40-01 £340 Available in more colours - see page 142. 133W £315 132W £315</p> <p><i>Only column taps are suitable for these washbasins: 1941C, 1941MP, 1941B.</i></p>	 <p>Ø400 x H170 mm Max. depth bowl 150 mm</p>	 <p>Ø400 x H165 mm Max. depth bowl 122 mm</p>	 <p>Ø390 x H150 mm Max. depth bowl 130 mm</p>	 <p>W390 x D390 x H130 mm Max. depth bowl 95 mm</p>

Measurements are for guidance only, exact measurement should be measured on the delivered basin.

KENSINGTON STORAGE recessed decorative framed doors and drawers

Fitted with mounting rails and brackets for easy adjustment and quick installation. Soft closing doors and drawers. V stands for left hand door and H stands for right hand door (see sketch). All furniture is delivered fully assembled.

Read more about the Miller Way on www.millerbathrooms.co.uk

<p>Tall Cabinet with 2 drawers floorstanding</p> <p>1 fixed and 2 adjustable wood shelves 2 drawers, bottom drawer with retaining bar</p>  <p>W420 x H1786 x D391 mm</p> <p><i>Left hand door</i></p> <table border="0"> <tr><td>White</td><td>492V-2</td><td>£1330</td></tr> <tr><td>Dark Grey</td><td>492V-9</td><td>£1330</td></tr> </table> <p><i>Right hand door</i></p> <table border="0"> <tr><td>White</td><td>492H-2</td><td>£1330</td></tr> <tr><td>Dark Grey</td><td>492H-9</td><td>£1330</td></tr> </table> <p><i>Optional</i> Handles page 147</p>	White	492V-2	£1330	Dark Grey	492V-9	£1330	White	492H-2	£1330	Dark Grey	492H-9	£1330	<p>Tall Cabinet with door storage and 2 drawers floorstanding</p> <p>1 fixed and 2 adjustable wood shelves 2 drawers, bottom drawer with retaining bar</p>  <p>W420 x H1786 x D391 mm</p> <p><i>Left hand door</i></p> <table border="0"> <tr><td>White</td><td>495V-2</td><td>£1550</td></tr> <tr><td>Dark Grey</td><td>495V-9</td><td>£1550</td></tr> </table> <p><i>Right hand door</i></p> <table border="0"> <tr><td>White</td><td>495H-2</td><td>£1550</td></tr> <tr><td>Dark Grey</td><td>495H-9</td><td>£1550</td></tr> </table> <p><i>Optional</i> Handles page 147</p>	White	495V-2	£1550	Dark Grey	495V-9	£1550	White	495H-2	£1550	Dark Grey	495H-9	£1550	<p>Storage Cabinet</p> <p>1 fixed and 2 adjustable glass shelves</p>  <p>W320 x H1138 x D265 mm</p> <p><i>Left hand door</i></p> <table border="0"> <tr><td>White</td><td>496V-2</td><td>£520</td></tr> <tr><td>Dark Grey</td><td>496V-9</td><td>£520</td></tr> </table> <p><i>Right hand door</i></p> <table border="0"> <tr><td>White</td><td>496H-2</td><td>£520</td></tr> <tr><td>Dark Grey</td><td>496H-9</td><td>£520</td></tr> </table> <p><i>Optional</i> Handles page 147</p>	White	496V-2	£520	Dark Grey	496V-9	£520	White	496H-2	£520	Dark Grey	496H-9	£520
White	492V-2	£1330																																				
Dark Grey	492V-9	£1330																																				
White	492H-2	£1330																																				
Dark Grey	492H-9	£1330																																				
White	495V-2	£1550																																				
Dark Grey	495V-9	£1550																																				
White	495H-2	£1550																																				
Dark Grey	495H-9	£1550																																				
White	496V-2	£520																																				
Dark Grey	496V-9	£520																																				
White	496H-2	£520																																				
Dark Grey	496H-9	£520																																				
<p>Tall Cabinet with 2 drawers wall hung</p> <p>1 fixed and 2 adjustable wood shelves 2 drawers, bottom drawer with retaining bar</p>  <p>W420 x H1628 x D391 mm</p> <p><i>Left hand door</i></p> <table border="0"> <tr><td>White</td><td>1492V-2</td><td>£1045</td></tr> <tr><td>Dark Grey</td><td>1492V-9</td><td>£1045</td></tr> </table> <p><i>Right hand door</i></p> <table border="0"> <tr><td>White</td><td>1492H-2</td><td>£1045</td></tr> <tr><td>Dark Grey</td><td>1492H-9</td><td>£1045</td></tr> </table> <p><i>Optional</i> Handles page 147</p>	White	1492V-2	£1045	Dark Grey	1492V-9	£1045	White	1492H-2	£1045	Dark Grey	1492H-9	£1045	<p>Tall Cabinet with door storage and 2 drawers wall hung</p> <p>1 fixed and 2 adjustable wood shelves 2 drawers, bottom drawer with retaining bar</p>  <p>W420 x H1628 x D391 mm</p> <p><i>Left hand door</i></p> <table border="0"> <tr><td>White</td><td>1495V-2</td><td>£1330</td></tr> <tr><td>Dark Grey</td><td>1495V-9</td><td>£1330</td></tr> </table> <p><i>Right hand door</i></p> <table border="0"> <tr><td>White</td><td>1495H-2</td><td>£1330</td></tr> <tr><td>Dark Grey</td><td>1495H-9</td><td>£1330</td></tr> </table> <p><i>Optional</i> Handles page 147</p>	White	1495V-2	£1330	Dark Grey	1495V-9	£1330	White	1495H-2	£1330	Dark Grey	1495H-9	£1330	<p>OPTIONAL</p>  <p>Choose between a right or left hand door on your storage cabinet. See sketch above. V is for left hand door and H is right hand door in the code no.</p>  <p>Handles</p> <p>Handles and knobs. Choose between various finishes, shapes and sizes to create your personal touch. See page 147.</p> <p>Colours</p> <table border="0"> <tr> <td></td> <td></td> </tr> <tr> <td>White</td> <td>Dark Grey</td> </tr> </table>			White	Dark Grey								
White	1492V-2	£1045																																				
Dark Grey	1492V-9	£1045																																				
White	1492H-2	£1045																																				
Dark Grey	1492H-9	£1045																																				
White	1495V-2	£1330																																				
Dark Grey	1495V-9	£1330																																				
White	1495H-2	£1330																																				
Dark Grey	1495H-9	£1330																																				
																																						
White	Dark Grey																																					



NEW YORK

40, 60, 80, 100, 120 cm

Smooth doors and drawers



Sharp and minimalist elegance. Stylish, clean surfaces give a clear reflection of the modern man's quest for simple beauty and harmony. Just like the city with the same name, this collection is filled with endless choices. Vanity units are available in different widths. The careful details such as the soft closure, the thin basin, the practical storage, the beautiful finish - these all create a special feeling for your bathroom which you will want to retain forever.

New York 100
Mirror Cabinet 55-4
Vanity 298-4
Basin Bloc 100
Tap 1936C
Storage 296V-4, 297H-4
Accessories Bond Brass



Double storage cabinets 294V-4 and 294H-4. Accessories Boston.



Down light DL2 provides fine lighting above the basin and tap.



40 Linear LED Mirror 59L with dimmable LED lighting. Down Light DL2. Accessories Bond black.



40 Linear LED Mirror Cabinet 52HL-4, dimmable LED lighting. Optional down light DL2.



Storage Cabinet 297 Practical door storage. 1 fixed wood shelf for stability and 2 adjustable glass shelves.



Tall Cabinet 293 1 fixed wood shelf for stability and 4 adjustable wood shelves. Choose right or left hand door.



Vanity unit 284H-2T, worktop 79-2, basin 174W1 and tap 1937C.



Smart storage for the smaller bathroom. Mirror 59-2, vanity unit 284H-2, basin 165W1, tap 1937C.



New York 60, Vanity 288-2



New York 120
Vanity 266-4
Mirror Cabinet 56-4G
Top Light L102
Down Light DL2
Basin 120
Tap 1936C
Accessories Boston

Smooth style doors and drawer fronts available in black stained oak and smooth white painted.

Soft closing drawers and doors. The drawers are sturdy, fully expandable and fitted with anti-slip mats. Vanity unit top drawers have compartments in solid natural oak that can easily be lifted out for cleaning.

The furniture is delivered fully assembled.

Vanity unit bottom drawers are fitted with an adjustable bar to stop larger items from moving. For your vanity you can choose between a full cover basin or a worktop with basin. See options below.

Complete the look with our range of taps and handles to add your own finished character to the bathroom furniture.

Colour

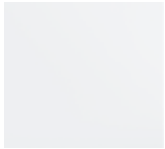

White



Black Stained Oak

Drawer Vanity sizes 60 / 80 / 100 / 120



Drawer Vanity in 3 ways:

1. Drawer Vanity with full cover basin
2. Drawer Vanity with worktop, basin and tap mounted on the worktop
3. Drawer Vanity with worktop and tap mounted on the basin

Door Vanity sizes 40 / 60



Door Vanity in 2 ways:

1. 35 cm shallow vanity, W400 mm
2. Door Vanity with worktop, W400 mm

Full Cover Ceramic Basins in two shapes

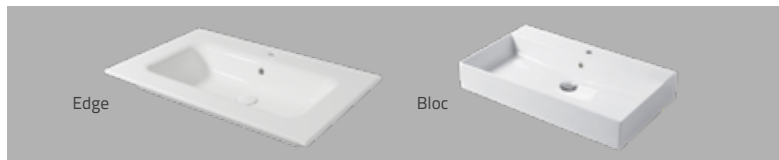

Several Basins for worktop, tap mounted on the work top



Basins for worktop, tap mounted on the basin



Stone Work top

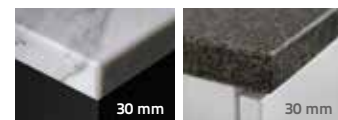

Carrara Marble

Grey Granite



Black Diabase

Green Marble

Limestone



Jura



Our bathroom furniture has a 10 year guarantee

DETAILS NEW YORK

Symbol shows that this feature is optional. **T**



Fully extendable, soft closing drawers. Tall drawers and lower drawer in the double vanity are equipped with an adjustable retaining bar that keeps bottles in place.



Top drawers are equipped with an adjustable divider in wood.



Anti slip mats in vanity units and storage cabinet drawers.



Drawers have straight insides which allows you to take advantage of the entire surface.



A variety of **basins** available. Image shows Edge 80 in Gloss White with colour matched ceramic Waste.



Practical storage solutions.



Ambient LED mirrors create a new updated look for your bathroom. Please see more on page 134.



Bathroom Cabinet 60, 80, 100, 120 are equipped with a centre divider in wood that gives a more flexible placement of the glass shelves.



Energy efficient top light in chrome finish. Neutral white light. **Option code no. L102**



LED Down light to match top light. **Option code no. DL2**



Linear LED Bathroom Cabinet dimmable lit bars. Energy efficient LED lighting with a white neutral sheen. **Complete with matching Down Light code no. DL2.**



Linear LED mirrors - in several sizes to match our vanities. **Complete with matching Down Light code no. DL2.**



Our bathroom furniture has a 10 year guarantee.



Many door vanity combinations to choose from, with worktops or full cover basins.

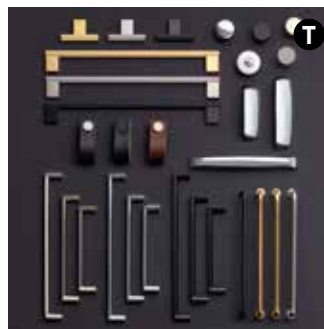

Handles and knobs. Choose between various finishes, shapes and sizes to create your personal touch. **Page 147.**

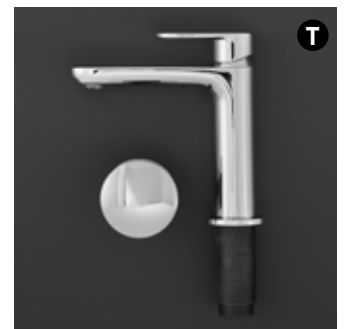

Taps. You can easily find a suitable and stylish favourite among our taps on **page 145.**

NEW YORK

Vanity units are fitted with mounting rails and brackets for easy adjustment and quick installation. Drawer fronts are adjustable in all directions. Fully extending drawers with soft close mechanism. The drawers include an anti slip mat and removable wooden dividers.

Vanity units, basins, taps and handles are priced separately. Double and high vanity units are equipped with a retaining bar.

Choose between full cover basin or worktop with basin. All furniture is delivered fully assembled.

Read more about the Miller Way on www.millerbathrooms.co.uk

Colour

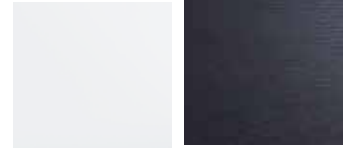





White Smooth

Black Stained Oak

40 / 60 / 80 / 100 / 120

Vanity with full cover basin

1 tall drawer or 2 drawers - price separately for vanity, basin and tap

60 Double	80 Double	100 Double	120 Double
			
Vanity size W590 x H580 x D455 mm Basin size see each model below	Vanity size W790 x H580 x D455 mm Basin size see each model below	Vanity size W990 x H580 x D455 mm Basin size see each model below	Vanity size W1190 x H580 x D455 mm Basin size see each model below
Vanity Unit 2 drawers	Vanity Unit 2 drawers	Vanity Unit 2 drawers	Vanity Unit 4 drawers
White 288-2 £655	White 289-2 £700	White 298-2 £775	White 266-2 £1350
Optional Black 288-4 £655	Optional Black 289-4 £840	Optional Black 298-4 £915	Optional Black 266-4 £1350
Optional Handles page 147	Optional Handles page 147	Optional Handles page 147	Optional Handles page 147
Basins			
<i>Gloss white ceramic basin for 60 vanity</i>	<i>Gloss white ceramic basin for 80 vanity</i>	<i>Gloss white ceramic basin for 100 vanity</i>	<i>Gloss white ceramic basin for 120 vanity</i>
Edge 110-60X46-01 £355	Edge 110-80X46-01 £455	Edge 110-100X46-01 £555	Edge 110-120X46-01 £755
Bloc 111-60X46-01 £425	Bloc 111-80X46-01 £525	Bloc 111-100X46-01 £655	Bloc 111-120X46-01 £855
For basins in other colours please see page 142	For basins in other colours please see page 142	For basins in other colours please see page 142	For basins in other colours please see page 142

Full cover Ceramic Basins



2 models and 4 colours
Colour match our full cover Basins with floor standing or wall hung Toilets.

Colour matched ceramic Waste available as an option. Please see images of basins in all sizes on page 142.

Edge



Bloc



Measurements are for guidance only, exact measurement should be measured on the delivered basin.

Vanity with doors

Size 40 or 60 cm - price separately for vanity, basin and tap

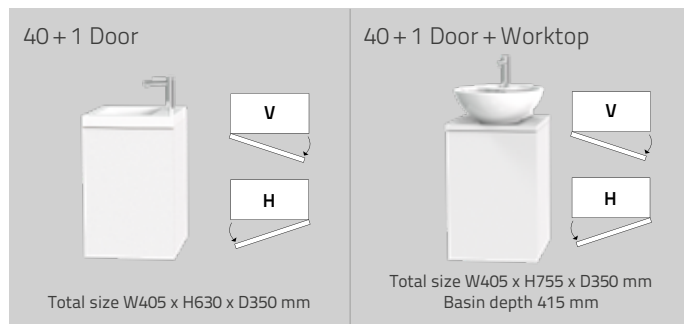

Left hand door

White **284V-2** £389
Black **284V-4** £485

Right hand door

White **284H-2** £389
Black **284H-4** £485

Basin

White **165W1** £255

Optional

Handles page 147

Left hand door

White **284V-2T** £389
Black **284V-4T** £485

Right hand door

White **284H-2T** £389
Black **284H-4T** £485

Basin

White **174W1** £210

White

135W £300

Optional

Handles page 147



Colour worktop for 40 + 1 Door code 284



Carrara Marble Grey Granite

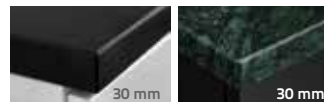

Black Diabase Green Marble



Jura Limestone

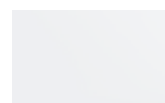

White

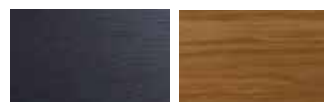

Black Stained Oak Natural Oak

25 mm worktop for 40 vanity with door

White **79-2** £68

Black **79-4** £110

Oak **79-5** £110

30 mm worktop for 40 vanity with door

Marble **400M** £499

Grey Granite **400G** £499



Diabase **400D** £540

Green Marble **400GM** £499

Jura **400J** £499

Drawer Vanity with worktop, basin and tap mounted on the worktop

Size 60, 80, 100, 120 - price separately for vanity, basin and tap

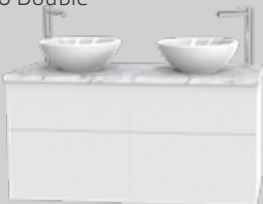
60 Double	80 Double	100 Double	120 Double
			
Size vanity W590 x H580 x D448 mm Size of basin see each model below	Size vanity W790 x H580 x D448 mm Size of basin see each model below	Size vanity W990 x H580 x D448 mm Size of basin see each model below	Size vanity W1180 x H580 x D448 mm Size of basin see each model below
Vanity Unit 2 drawers White 288-2T £655 <i>Optional</i> Handles page 147	Vanity Unit 2 drawers White 289-2T £700 Black 289-4T £840 <i>Optional</i> Handles page 147	Vanity Unit 2 drawers White 298-2T £775 Black 298-4T £915 <i>Optional</i> Handles page 147	Vanity Unit 4 drawers White 266-2T £1350 <i>Optional</i> Handles page 147
Choose Worktop <i>Worktop for 60 vanity</i> Marble 600M-X £620 Grey Granite 600G-X £620 Diabase 600D-X £720 Green Marble 600GM-X £620 Jura 600J-X £620 Size worktop W595 x D455	<i>Worktop for 80 vanity</i> Marble 800M-X £720 Grey Granite 800G-X £720 Diabase 800D-X £825 Green Marble 800GM-X £720 Jura 800J-X £720 Size worktop W795 x D455 mm	<i>Worktop for 100 vanity</i> Marble 1000M-X £825 Grey Granite 1000G-X £825 Diabase 1000D-X £979 Green Marble 1000GM-X £825 Jura 1000J-X £825 Size worktop W995 x D455 mm	<i>Worktop for 120 vanity</i> Marble 1200M-X £1029 Grey Granite 1200G-X £1029 Diabase 1200D-X £1239 Green Marble 1200GM-X £1029 Jura 1200J-X £1029 Size worktop W1200 x D455 mm

Waste and tap hole position

The worktops are pre-cut with tap hole and waste holes as per diagram.



to the right **-H**



add **-H** after the worktop code no example: 600M-H



to the left **-V**

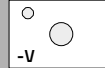

add **-V** after the worktop code no example: 600M-V

120/160 left + right



example: 1600M-HV

120/160 to the left **-V**

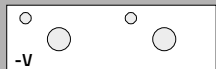



example: 1600M-V

120/160 to the right **-H**



example: 1600M-H

Basin for worktop, column tap mounted on the side of the basin

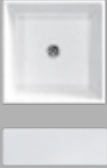



130-R40-01	131-R40-01	133W	132W
			
Ø400 x H170 mm Max. depth bowl 150 mm	Ø400 x H165 mm Max. depth bowl 122 mm	Ø390 x H150 mm Max. depth bowl 130 mm	W390 x D390 x H130 mm Max. depth bowl 95 mm

130-R40-01 £340 Available in more colours – see page 142
131-R40-01 £340 Available in more colours – see page 142
133W £315
132W £315

Only column taps are suitable for these washbasins: 1941C, 1941MP, 1941B.

Drawer Vanity with worktop, basin and tap mounted on the basin

Size 60, 80, 100, 120 - price separately for vanity, basin and tap

60 Double	80 Double	100 Double	120 Double
			
Size vanity W590 x H580 x D448 mm Size of basin see each model below	Size vanity W790 x H580 x D448 mm Size of basin see each model below	Size vanity W990 x H580 x D448 mm Size of basin see each model below	Size vanity W1180 x H580 x D448 mm Size of basin see each model below
Vanity Unit 2 drawers White 288-2T £655 <i>Optional</i> Handles page 147	Vanity Unit 2 drawers White 289-2T £700 Black 289-4T £840 <i>Optional</i> Handles page 147	Vanity Unit 2 drawers White 298-2T £775 Black 298-4T £915 <i>Optional</i> Handles page 147	Vanity Unit 4 drawers White 266-2T £1350 <i>Optional</i> Handles page 147
Choose Worktop <i>Worktop for 60 vanity</i> Marble 600M £620 Grey Granite 600G £620 Diabase 600D £720 Green Marble 600GM £620 Jura 600J £620 <i>Size worktop W595 x D455</i>	<i>Worktop for 80 vanity</i> Marble 800M £720 Grey Granite 800G £720 Diabase 800D £825 Green Marble 800GM £720 Jura 800J £720 <i>Size worktop W795 x D455 mm</i>	<i>Worktop for 100 vanity</i> Marble 1000M £825 Grey Granite 1000G £825 Diabase 1000D £979 Green Marble 1000GM £825 Jura 1000J £825 <i>Size worktop W995 x D455 mm</i>	<i>Worktop for 120 vanity</i> Marble 1200M £1029 Grey Granite 1200G £1029 Diabase 1200D £1239 Green Marble 1200GM £1029 Jura 1200J £1029 <i>Size worktop W1200 x D455 mm</i>

Stone worktop 30 mm

Up to 6 weeks delivery



Grey Swedish
Granite



Carrara Marble



Black Diabase



Green Marble



Limestone

Up to 6 weeks delivery

Waste and tap hole position

The worktops are pre-cut with tap hole and waste holes as per diagram.

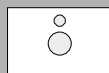

60, 80, 100



120, 160

Ceramic basins in four shapes

116W1 £470
171W1 £299
173W1 £299

For more information on each basin please see page 142.

116W1



W500 x D495 x H180 mm

171W1



Ø460 x H130 mm

173W1







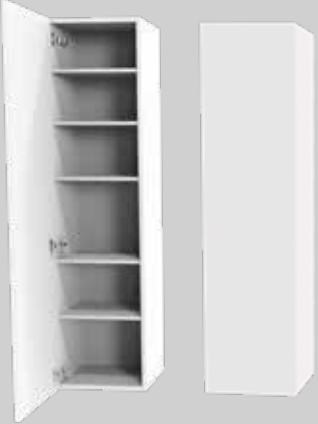

W550 x H130 x D450 mm

NEW YORK STORAGE smooth doors and drawers

Fitted with mounting rails and brackets for easy adjustment and quick installation. Soft closing doors and drawers. V stands for left hand door and H stands for right hand door (see sketch). All furniture is delivered fully assembled.

Read more about the Miller Way on www.millerbathrooms.co.uk

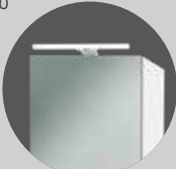
<p>Tall Cabinet 1 fixed and 4 adjustable wood shelves</p>  <p>W400 x H1690 x D380 mm</p> <p><i>Left hand door</i> White 293V-2 £835 Black 293V-4 £1100</p> <p><i>Right hand door</i> White 293H-2 £835 Black 293H-4 £1100</p> <p><i>Optional Handles</i> page 147</p>	<p>Tall Cabinet with door storage 1 fixed and 4 adjustable wood shelves Door storage with 3 shelves</p>  <p>W400 x H1690 x D380 mm</p> <p><i>Left hand door</i> White 294V-2 £975 Black 294V-4 £1355</p> <p><i>Right hand door</i> White 294H-2 £975 Black 294H-4 £1355</p> <p><i>Optional Handles</i> page 147</p>	<p>Tall Cabinet with 2 drawers 1 fixed and 3 adjustable wood shelves 2 drawers, bottom drawer with retaining bar</p>  <p>W400 x H1690 x D380 mm</p> <p><i>Left hand door</i> White 291V-2 £975 Black 291V-4 £1300</p> <p><i>Right hand door</i> White 291H-2 £975 Black 291H-4 £1300</p> <p><i>Optional Handles</i> page 147</p>
<p>Storage Cabinet 1 fixed and 2 adjustable glass shelves</p>  <p>W400 x H1111 x D255 mm</p> <p><i>Left hand door</i> White 296V-2 £570</p> <p><i>Right hand door</i> White 296H-2 £570</p> <p><i>Optional Handles</i> page 147</p>	<p>Storage Cabinet with door storage 1 fixed and 2 adjustable glass shelves Door storage with 3 shelves</p>  <p>W400 x H1111 x D255 mm</p> <p><i>Left hand door</i> White 297V-2 £750</p> <p><i>Right hand door</i> White 297H-2 £750</p> <p><i>Optional Handles</i> page 147</p>	<p>Mirror Cabinet with double sided mirror door 1 fixed and 2 adjustable glass shelves, Frosted 20 mm edge at the opening on the outside Shown with optional top light L102</p>  <p>W400 x H1111 x D242 mm</p> <p><i>Left hand door</i> White 96V-2 £595 Black 96V-4 £750</p> <p><i>Right hand door</i> White 96H-2 £595 Black 96H-4 £750</p> <p><i>Optional Top Light</i> L102 £130</p> <p>Optional - This mirror cabinet is prepared for LED top light L102 £130</p> 

Storage Cabinet

1 fixed wooden shelf

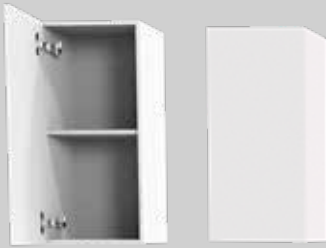

W275 x H590 x D221 mm
Only available in Black Stained Oak

Left hand door

Black **234V-4** £420

Right hand door

Black **234H-4** £420

Optional

Handles page 147

Storage Cabinet

1 fixed wooden divider

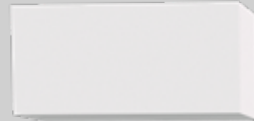

W590 x H275 x D221 mm
Only available in Black Stained Oak

Flap door opens up

Black **1250-4** £420

Optional

Handle page 147

OPTIONAL

Handles



Handles and knobs. Choose between various finishes, shapes and sizes to create your personal touch. See page 147.

Right or Left Hand Door?

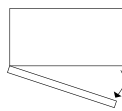

V = Left hand door

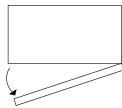

H = Right hand door

Choose between a right or left hand door on your storage cabinet. See sketch above. V is for left hand door and H is right hand door in the code no.

Colours

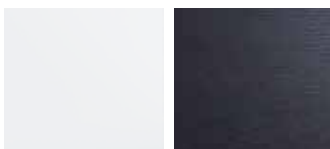

White

Black Stained Oak

LONDON

40, 60, 80, 100, 120 cm

Framed doors and drawer fronts

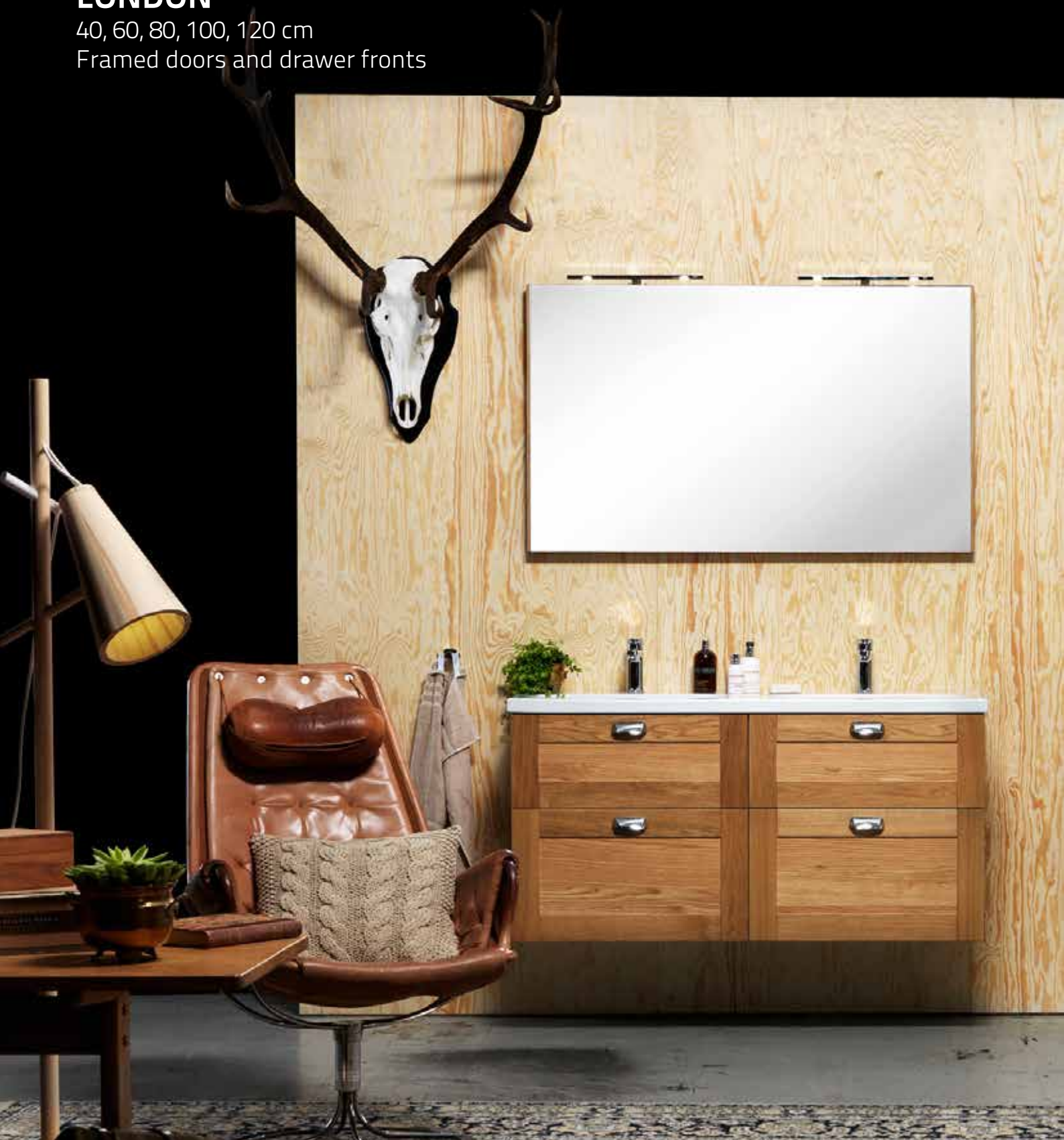

Classic beauty. Tasteful setting of drawers and fronts which enhances and deepens the impression of refined art. Inviting, clean lines with a beautiful finish that makes this collection obviously welcome in today's bathrooms. With the experience we have we know that all bathrooms are different - just like humans, so London is available in various sizes and in classic colours. The attention to the smallest detail adds to the comfort and knowledge that feeling nice, like beauty, is timeless.

London 120
Mirror 63-5
Vanity Unit 566-5
Taps 1936C



London 120 vanity with 4 drawers and full cover ceramic with 2 bowls.



London 60 Vanity with drawers.



Doors and drawers are 19 mm and gives a solid impression. Natural oak doors are mostly made of solid oak.

Framed doors and drawer fronts are available in natural oak. Soft closing drawers and doors. The drawers are sturdy, fully expandable and fitted with anti-slip mats. Vanity unit top drawers have compartments in solid natural oak that can easily be lifted out for cleaning. Vanity unit bottom drawers are fitted with an adjustable bar to stop larger items from moving.

For your vanity you can choose between a full cover basin or a worktop with basin. See options below.

Complete the look with our range of taps and handles to add your own finished character to the bathroom furniture.

The furniture is delivered fully assembled.

Colour



Natural Oak

Drawer Vanity sizes 60 / 80 / 100 / 120



1. Drawer Vanity with full cover basin
2. Drawer Vanity with worktop, basin and tap mounted on the worktop
3. Drawer Vanity with worktop and tap mounted on the basin

Door Vanity sizes 40 / 60



- Door Vanity in 2 ways:
1. 35 cm shallow vanity, W400 mm
 2. Door Vanity with worktop, W400 mm

Full Cover Ceramic Basin in two shapes

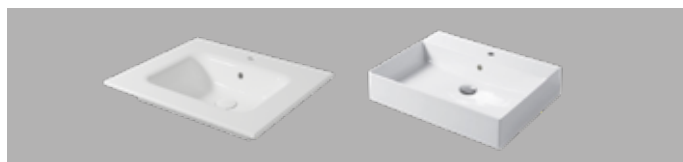

Basins for worktop, tap mounted on the worktop



Basin for worktop, tap mounted on the basin



Stone Work top

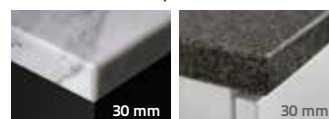

Carrara Marble

Grey Granite

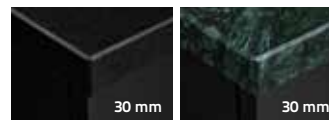

Black Diabase

Green Marble

Limestone



Jura



Our bathroom furniture has a 10 year guarantee

DETAILS LONDON

Symbol shows that this feature is optional. **T**



Top drawers are equipped with an adjustable divider in wood.



Anti slip mats in vanity units and storage cabinet drawers.



Drawers have straight insides which allows you to take advantage of the entire surface.



Fully extendable, soft closing drawers. Tall drawers and lower drawer in the double vanity are equipped with an adjustable retaining bar that keeps bottles in place.



A variety of **basins** available. Image shows Edge 80 in Gloss White with colour matched ceramic Waste.



Practical storage solutions.



Matching Storage Our cabinets are available in several sizes and colours customized to optimize your storage.



Bathroom Cabinet 60, 80, 100, 120 are equipped with a centre divider in wood that gives a more flexible placement of the glass shelves.



Energy efficient top light in chrome finish. Neutral white light. **Option code no. L102**



LED Down light to match top light. **Option code no. DL2**



Linear LED Bathroom Cabinet dimmable lit bars. Energy efficient LED lighting with a white neutral sheen. Complete with **matching Down Light code no. DL2.**



Doors and drawers are 19 mm and gives a solid impression. Natural Oak and Black Stained Oak are solid oak.



Our bathroom furniture has a 10 year guarantee.



Chrome handle in classic style.

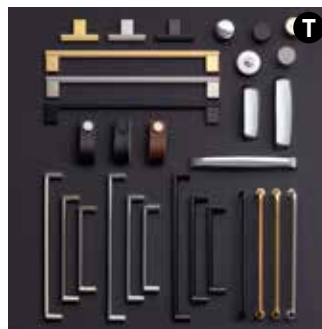

Handles and knobs. Choose between various finishes, shapes and sizes to create your personal touch. **Page 147.**



Taps. You can easily find a suitable and stylish favourite among our taps on **page 145.**

LONDON

Vanity units are fitted with mounting rails and brackets for easy adjustment and quick installation. Drawer fronts are adjustable in all directions. Fully extending drawers with soft close mechanism. The drawers include an anti slip mat and removable wooden dividers.

Vanity Units, basins, taps and handles are priced separately. Double and high vanity units are equipped with a retaining bar.

Choose between full cover basin or worktop with basin. All furniture is delivered fully assembled.

Read more about the Miller Way on www.millerbathrooms.co.uk

Colour







Natural Oak

40 / 60 / 80 / 100 / 120

Vanity with full cover basin

1 tall drawer or 2 drawers - price separately for vanity, basin and tap

60 Double	80 Double	100 Double	120 Double
			
Vanity size W590 x H580 x D455 mm Basin size see each model below	Vanity size W790 x H580 x D455 mm Basin size see each model below	Vanity size W990 x H580 x D455 mm Basin size see each model below	Vanity size W1190 x H580 x D455 mm Basin size see each model below
Vanity Unit 2 drawers Oak 588-5 £840 Optional Handles page 147	Vanity Unit 2 drawers Oak 589-5 £925 Optional Handles page 147	Vanity Unit 2 drawers Oak 598-5 £975 Optional Handles page 147	Vanity Unit 4 drawers Oak 566-5 £1750 Optional Handles page 147
Basin Gloss white ceramic basin for 60 vanity unit Edge 110-60X46-01 £355 Bloc 111-60X46-01 £425 For basins in more colours please see page 142.	Gloss white ceramic basin for 80 vanity unit Edge 110-80X46-01 £455 Bloc 111-80X46-01 £525 For basins in more colours please see page 142.	Gloss white ceramic basin for 100 vanity unit Edge 110-100X46-01 £555 Bloc 111-100X46-01 £655 For basins in more colours please see page 142.	Gloss white ceramic basin for 120 vanity unit Edge 110-120X46-01 £755 Bloc 111-120X46-01 £855 - 120 vanity has 2 bowls For basins in more colours please see page 142.

Shallow Vanity with doors



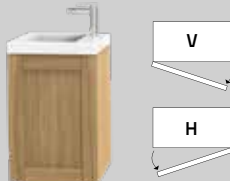
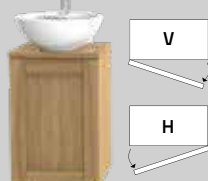
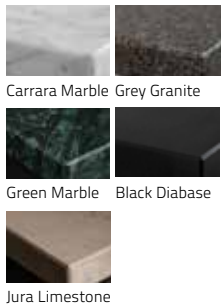

Size 40 or 60 cm - price separately for vanity, basin and tap

40 + 1 Door	40 + 1 Door + Worktop	Worktop for 40 + 1, code 584-
		
Total size W405 x H630 x D350 mm	Total size W405 x H755 x D350 mm Basin depth 415 mm	25 mm worktop for 40 vanity with door White 79-2 £68 Oak 79-5 £110 30 mm worktop for 40 vanity with door Marble 400M £499 Granite 400G £499 Diabase 400D £540 Green Marble 400GM £499 Jura 400J £499 Size worktop W403 x D358 mm
Left hand door Oak 584V-5 £525 Right hand door Oak 584H-5 £525 Basin White 165W1 £255 Optional Handles page 147	Left hand door Oak 584V-5T £525 Right hand door Oak 584H-5T £525 Basin White 174W1 £210 White 135W £300 Optional Handles page 147	

Basin	165W1	174W1	135W
			
405 mm	415 mm	Ø 330 mm	
355 mm	Ø 400 mm		

Drawer Vanity with worktop, basin and tap mounted on the worktop

Size 60, 80, 100, 120 - price separately for vanity, basin and tap

60 Double	80 Double	100 Double	120 Double
			
Size vanity W590 x H580 x D448 mm Size of basin see each model below	Size vanity W790 x H580 x D448 mm Size of basin see each model below	Size vanity W990 x H580 x D448 mm Size of basin see each model below	Size vanity W1180 x H580 x D448 mm Size of basin see each model below
Vanity Unit 2 drawers Oak 588-5T £840 <i>Optional</i> Handles page 147	Vanity Unit 2 drawers Oak 589-5T £925 <i>Optional</i> Handles page 147	Vanity Unit 2 drawers Oak 598-5T £975 <i>Optional</i> Handles page 147	Vanity Unit 4 drawers Oak 566-5T £1750 <i>Optional</i> Handles page 147
Choose Worktop <i>Worktop for 60 vanity</i> Marble 600M-X £620 Granite 600G-X £620 Diabase 600D-X £720 Green Marble 600GM-X £620 Jura 600J-X £620 <i>Size worktop W595 x D455</i>	<i>Worktop for 80 vanity</i> Marble 800M-X £720 Granite 800G-X £720 Diabase 800D-X £825 Green Marble 800GM-X £720 Jura 800J-X £720 <i>Size worktop W795 x D455 mm</i>	<i>Worktop for 100 vanity</i> Marble 1000M-X £825 Granite 1000G-X £825 Diabase 1000D-X £979 Green Marble 1000GM-X £825 Jura 1000J-X £825 <i>Size worktop W995 x D455 mm</i>	<i>Worktop for 120 vanity</i> Marble 1200M-X £1029 Granite 1200G-X £1029 Diabase 1200D-X £1239 Green Marble 1200GM-X £1029 Jura 1200J-X £1029 <i>Size worktop W1200 x D455 mm</i>

Stone worktop 30 mm

Up to 6 weeks delivery



Grey Granite Carrara Marble Black Diabase Green Marble Jura

Limestone

Up to 6 weeks delivery

Waste and tap hole position

The worktops are pre-cut with tap hole and waste holes as per diagram.



to the right **-H**



add **-H** after the worktop code no example: 600M-H



to the left **-V**

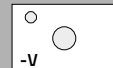

add **-V** after the worktop code no example: 600M-V

120/160 left + right



-HV

example: 1600M-HV

120/160 to the left **-V**



-V

example: 1600M-V



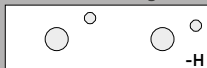

120/160 to the right **-H**



-H





example: 1600M-H

Basin for worktop, column tap mounted on the side of the basin

<p>130-R40-01 £340 Available in more colours – see page 142</p> <p>131-R40-01 £340 Available in more colours – see page 142</p> <p>133W £315</p> <p>132W £315</p> <p><i>Only column taps are suitable for these washbasins: 1941C, 1941MP, 1941B.</i></p>	<p>130-R40-01</p>  <p>Ø400 x H170 mm Max. depth bowl 150 mm</p>	<p>131-R40-01</p>  <p>Ø400 x H165 mm Max. depth bowl 122 mm</p>	<p>133W</p>  <p>Ø390 x H150 mm Max. depth bowl 130 mm</p>	<p>132W</p>  <p>W390 x D390 x H130 mm Max. depth bowl 95 mm</p>
---	---	---	---	---

Drawer Vanity with worktop, basin and tap mounted on the basin

Size 60, 80, 100, 120 - price separately for vanity, basin and tap

60 Double	80 Double	100 Double	120 Double
			
Size vanity W590 x H580 x D448 mm Size of basin see each model below	Size vanity W790 x H580 x D448 mm Size of basin see each model below	Size vanity W990 x H580 x D448 mm Size of basin see each model below	Size vanity W1180 x H580 x D448 mm Size of basin see each model below
Vanity Unit 2 drawers Oak 588-5T £840 Optional Handles page 147	Vanity Unit 2 drawers Oak 589-5T £925 Optional Handles page 147	Vanity Unit 2 drawers Oak 598-5T £975 Optional Handles page 147	Vanity Unit 4 drawers Oak 566-5T £1750 Optional Handles page 147
Choose Worktop Worktop for 60 vanity Marble 600M £620 Granite 600G £620 Diabase 600D £720 Green Marble 600GM £620 Jura 600J £620 Size worktop W595 x D455	Worktop for 80 vanity Marble 800M £720 Granite 800G £720 Diabase 800D £825 Green Marble 800GM £720 Jura 800J £720 Size worktop W795 x D455 mm	Worktop for 100 vanity Marble 1000M £825 Granite 1000G £825 Diabase 1000D £979 Green Marble 1000GM £825 Jura 1000J £825 Size worktop W995 x D455 mm	Worktop for 120 vanity Marble 1200M £1029 Granite 1200G £1029 Diabase 1200D £1239 Green Marble 1200GM £1029 Jura 1200J £1029 Size worktop W1200 x D455 mm

Stone worktop 30 mm

Up to 6 weeks delivery



Grey Granite



Carrara Marble



Black Diabase



Green Marble



Jura

Limestone

Up to 6 weeks delivery

Waste and tap hole position

The worktops are pre-cut with tap hole and waste holes as per diagram.

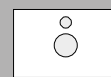

60, 80, 100



120, 160

Ceramic basins in four shapes

116W1	£470
117W1	£500
171W1	£299
173W1	£299

Measurements of each basin is available on millerbathrooms.co.uk

Taps Choose between several models and colours see page 145.

116W1



W500 x D495 x H180 mm

171W1



Ø460 x H180 mm

173W1



W550 x H130 x D450 mm

LONDON STORAGE OPTIONS

Handles



Handles and knobs. Choose between various finishes, shapes and sizes to create your personal touch. See page 147.

Right or Left Hand Door?

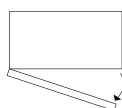

V = Left hand door

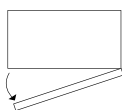

H = Right hand door

Choose between a right or left hand door on your storage cabinet. See sketch above. V is for left hand door and H is right hand door in the code no.

Colour



Natural Oak

LONDON STORAGE framed doors and drawers

Fitted with mounting rails and brackets for easy adjustment and quick installation. Soft closing doors and drawers. V stands for left hung door and H stands for right hung door (see sketch). All furniture is delivered fully assembled.

Read more about the Miller Way on www.millerbathrooms.co.uk

Tall Cabinet

1 fixed and 4 adjustable wood shelves



W400 x H1690 x D380 mm

Left hand door

Oak **593V-5** £1200

Right hand door

Oak **593H-5** £1200

Optional

Handles page 147

Tall Cabinet with door storage

1 fixed and 4 adjustable wood shelves
Door storage with 3 shelves



W400 x H1690 x D380 mm

Left hand door

Oak **594V-5** £1315

Right hand door

Oak **594H-5** £1315

Optional

Handles page 147

Storage Cabinet

1 fixed and 2 adjustable glass shelves



W400 x H1111 x D255 mm

Left hand door

Oak **596V-5** £715

Right hand door

Oak **596H-5** £715

Optional

Handles page 147

Storage Cabinet with door storage

1 fixed and 2 adjustable glass shelves
Door storage with 3 shelves



W400 x H1111 x D255 mm

Left hand door

Oak **597V-5** £950

Right hand door

Oak **597H-5** £950

Optional

Handles page 147

Mirror Cabinet with double sided mirror door

1 fixed and 2 adjustable glass shelves,
Frosted 20 mm edge at the opening on the outside
Shown with optional top light L102



W400 x H1111 x D242 mm

Left hung door

White **96V-2** £595

Oak **96V-5** £775

Right hung door

White **96H-2** £595

Oak **96H-5** £775

Optional

Top Light **L102** £130

Optional - This mirror cabinet is prepared for LED top light **L102** £130

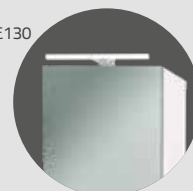

MIRROR CABINET LINEAR LED

Integrated dimmable light with touch sensor. Technically powerful LED light creates illuminated lines with better colour reproduction. Perfect for makeup. IP44 rated. Fitted with mounting rails and brackets for adjustable & quick installation. Soft closing double sided mirror doors. Choose left or right hand door for the 40 bathroom cabinet, see illustration below. All furniture is delivered fully assembled.

Read more about the Miller Way on www.millerbathrooms.co.uk

Colours

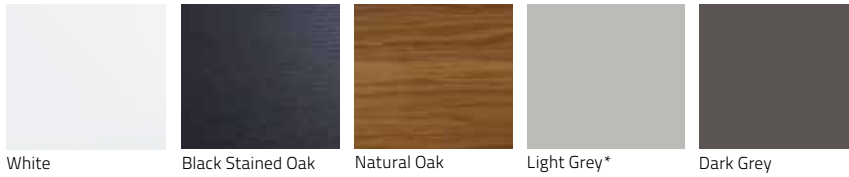

40 / 60 / 80 / 100

For Furniture Ranges:
Kensington, New York, London

40 linear led



W404 x H700 x D145 m

2 x glass shelves, IP44

Left hand door

White	52VL-2	£625
Black	52VL-4	£785
Oak	52VL-5	£785
Light Grey*	52VL-8	£625

Right hand door

White	52HL-2	£625
Black	52HL-4	£785
Oak	52HL-5	£785
Light Grey*	52HL-8	£625

Optional

Down Light	DL2	£79
2 extra glass shelves	54-190	£21

60 linear led



W590 x H700 x D145 mm

4 x glass shelves, centre wood divider, IP44

White	53L-2	£820
Black	53L-4	£985
Oak	53L-5	£985
Light Grey*	53L-8	£820
Dark Grey	53L-9	£890

Optional

Down Light	DL2	£79
2 extra glass shelves	53-190	£19

Optional Kensington furniture

Decorative top white	06-453-2	£35
Decorative top dark Grey	06-453-9	£35

80 linear led



W790 x H700 x D145 mm

4 x glass shelves, centre wood divider, IP44

White	54L-2	£920
Black	54L-4	£1065
Oak	54L-5	£1065
Light Grey*	54L-8	£920
Dark Grey	54L-9	£1015

Optional

Down Light	DL2	£79
2 extra glass shelves	54-190	£21

Optional Kensington furniture

Decorative top white	06-454-2	£40
Decorative top dark Grey	06-454-9	£40

100 linear led

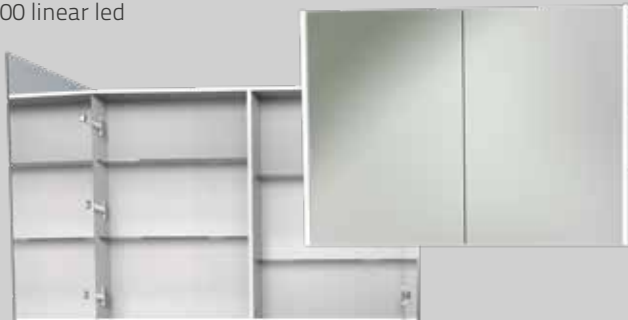

W990 x H700 x D145 mm

4 x glass shelves, centre wood divider, IP44

White	55L-2	£940
Black	55L-4	£1120
Oak	55L-5	£1120
Light Grey*	55L-8	£940
Dark Grey	55L-9	£1070

Optional

Down Light	DL2	£79
2 extra glass shelves	55-190	£23

Optional Kensington furniture

Decorative top white	06-455-2	£45
Decorative top dark Grey	06-455-9	£45

*Only the sides are Light Grey, inside of the cabinets are white painted.

DETAILS



Centre divider in wood for stability and a more flexible placement of the shelves.



Light shines both forward and inward on cabinets.

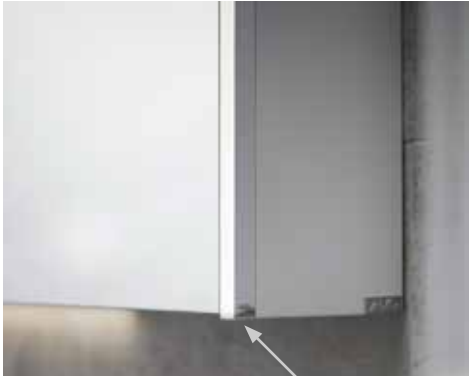

Control the brightness with a touch sensor. Our new Bathroom Cabinet memorises the latest desired brightness when switched on and off.



The lighting is integrated in the sides of the bathroom cabinets and measures 16 mm x 16 mm. Matching Down Light DL2.



For Bathroom Collection Kensington we offer a Decorative Top made of wood to fix on top of the Linear LED Mirror Cabinets. See Optional for Kensington: 60, 80 and 100 Linear Led.

OPTIONAL



Down Light Linear Led
 Chrome **DL2** £79
 Chrome finish. White neutral sheen. IP44. Dimmable with Linear LED Mirror Cabinet.
Can only be combined with Linear LED Mirror Cabinet, Linear LED Mirrors and Linead LED Top Light L102.



Extra glass shelves
 For right size please see optional under each bathroom cabinet. Shelf brackets are included.



Decorative Top
 For our Bathroom Collection Kensington we offer a Decorative Top in wood to match the vanities.
 These are only available for Mirror Cabinets 60, 80 and 100 cm. Same size as the Kensington vanities. In Colours White and Dark Grey.

MIRROR CABINET with thin wooden frame

You choose if you want Top and Down Light to your Mirror Cabinet. There are two different models of Top and Down lights. Product images below are shown with Top Light L102. Price separately for Mirror Cabinet and Top/Down Light.

Fitted with mounting rails and brackets for adjustable & quick installation. Soft closing double sided mirror doors. Choose left or right hung door for the 40 bathroom cabinet, see illustration below. All furniture is delivered fully assembled.

Read more about the Miller Way on www.millerbathrooms.co.uk

Colours

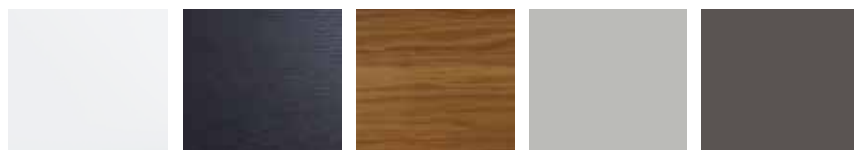

White

Black Stained Oak

Natural Oak

Light Grey*

Dark Grey

40 / 60 / 80 / 100

For Furniture Ranges:
Kensington, New York, London

40 Mirror Cabinet



W404 x H700 x D145 mm

2 x glass shelves

Left hand door

White **52V-2G** £420

Black **52V-4G** £525

Oak **52V-5G** £525

Light Grey **52V-8G** £420

Right hand door

White **52H-2G** £420

Black **52H-4G** £525

Oak **52H-5G** £525

Light Grey **52H-8G** £420

Optional

Top Light **L102** £130

Down Light **DL2** £79

2 extra glass shelves **54-190** £21

60 Mirror Cabinet



W590 x H700 x D145 mm

4 x glass shelves, centre divider in wood

White **53-2G** £580

Black **53-4G** £745

Oak **53-5G** £745

Light Grey **53-8G** £580

Dark Grey **53-9G** £580

Optional

Top Light **L102** £130

Down Light **DL2** £79

2 extra glass shelves **53-190** £19

80 Mirror Cabinet



W790 x H700 x D145 mm

4 x glass shelves, centre divider in wood

White **54-2G** £675

Black **54-4G** £825

Oak **54-5G** £825

Light Grey **54-8G** £675

Dark Grey **54-9G** £675

Optional

Top Light **L102** £130

Down Light **DL2** £79

2 extra glass shelves **54-190** £21

100 Mirror Cabinet

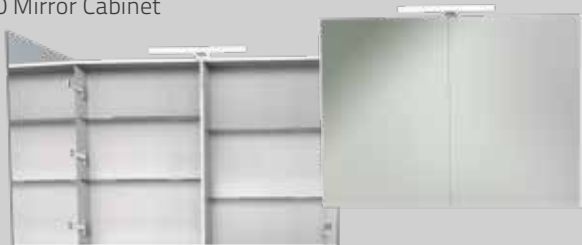

W990 x H700 x D145 mm

4 x glass shelves, centre divider in wood

1 extra hinge for stability

White **55-2G** £725

Black **55-4G** £900

Oak **55-5G** £900

Light Grey **55-8G** £725

Dark Grey **55-9G** £725

Optional

Top Light **L102** £130

Down Light **DL2** £79

2 extra glass shelves **55-190** £23

120 Mirror Cabinet



W1180 x H700 x D145 mm
Choose 2 top/down lights

8 x glass shelves, 2 x 60 cabinets

Double centre divider in wood

White **56-2G** £1170

Black **56-4G** £1545

Oak **56-5G** £1545

Light Grey* **56-8G** £1170

Optional

Top Light **L102** £130

Down Light **DL2** £79

2 extra glass shelves **53-190** £19

MIRROR CABINET with thin wooden frame

DETAILS



Dimmer via the "DIM" sensor located at the bottom / end of the right light profile. Press and hold your finger against the sensor to increase / decrease the amount of light and release the sensor when you have reached desired amount of light. The cabinet will then remember the last set brightness when you turn on the cabinet next time.

Thin wooden edge along the sides of the cabinets. Mirror Cabinet 120 is shown above with Linear LED Top and Down Light, code no. L102 and DL2.

OPTIONAL MIRROR CABINET



Top Light Linear Led

Chrome **L102** £130
White neutral sheen. IP44.
Dimmable.
1 top light fits 40, 60, 80 and 100.
Choose 2 top lights for 120.



Down Light Linear Led

Size W350 x H10 x D24 mm

Chrome **DL2** £79
Chrome finish. White neutral sheen.
IP44. Dimmable with Top Light L102.
Can only be combined with Linear LED Mirror Cabinet, Linear LED Mirrors and Linear LED Top Light L102.



Extra glass shelves

For right size please see optional under each bathroom cabinet.
Shelf brackets are included.

MIRROR LINEAR LED

Integrated dimmable light with touch sensor. Technically powerful LED light creates illuminated lines with better colour reproduction. Perfect for makeup. IP44 rated. Down Light is available as an option for Linear Led Mirror. Fitted with mounting rails and brackets for adjustable & quick installation. All furniture is delivered fully assembled.

Read more about the Miller Way on www.millerbathrooms.co.uk

Colour



40 / 60 / 80 / 100

For Furniture Ranges:
City, Kensington, New York, London

Chrome/Mirror

40 linear LED



W407 x H700 x D50 mm

Mirror with dimmable linear LED lighting
Chrome **59L** £445

Optional
Down Light **DL2** £79

60 linear LED



W607 x H700 x D50 mm

Mirror with dimmable linear LED lighting
Chrome **60L** £495

Optional
Down Light **DL2** £79

80 linear LED



W807 x H700 x D50 mm

Mirror with dimmable linear LED lighting
Chrome **61L** £545

Optional
Down Light **DL2** £79

100 linear LED



W1007 x H700 x D50 mm

Mirror with dimmable linear LED lighting
Chrome **62L** £595

Optional
Down Light **DL2** £79

DETAILS



Mirror 59L. Down Light DL2



Control the brightness with a touch sensor. Our new Bathroom Cabinet memorises the latest desired brightness when switched on and off.

OPTIONAL



Chrome **DL2** £79
Chrome finish. White neutral sheen.
IP44. Dimmable with Top Light L102.

Can only be combined with Linear LED Mirror Cabinet, Linear LED Mirrors and Linear LED Top Light L102.



Mirror 59L. Floating effect.

AMBIENT LED MIRRORS

Oval 40x80 / 50x100 cm

Round 70 cm

Round 90 cm

Dimmable LED Mirrors with indirect light.
Controlled with touch-sensor.
Choose with or without bevelled edge
for a modern or classic look.



Ambient 70 LED Mirror
Vanity City 60 Cotton Cream
Basin Edge 60 Cotton Cream
Tap 1940C
Wall Hung Toilet Cotton Cream
Accessories Miami



Ambient 70

Modern look with flush edge

161-R70-L
Round Ø70 cm

£499



Ambient 90

Modern look with flush edge

161-R90-L
Round Ø90 cm

£599



Ambient Oval

Modern look with flush edge

161-40x80-L 40x80 cm
161-50x100-L 50x100 cm

£499

£549



Ambient 70 Classic

Classic look with 15mm bevelled edge

161-R70-BL
Round Ø70 cm

£599



Ambient 90 Classic

Classic look with 15mm bevelled edge

161-R90-BL
Round Ø90 cm

£699



Ambient Oval Classic

Classic look with 15mm bevelled edge

161-40x80-BL 40x80 cm
161-50x100-BL 50x100 cm

£599

£649

Ambient LED Mirrors

- Connects to on/off switch or solid current
- Stepless adjustment from 3000K - 6000K
- Button lights up dimly when mirror is off
- Built-in dimmer
- Demister pad
- IP44

The same button controls:

- On / off
- Cold / warm light
- Brightness



Dimmable
LED Lighting



Touch-sensor

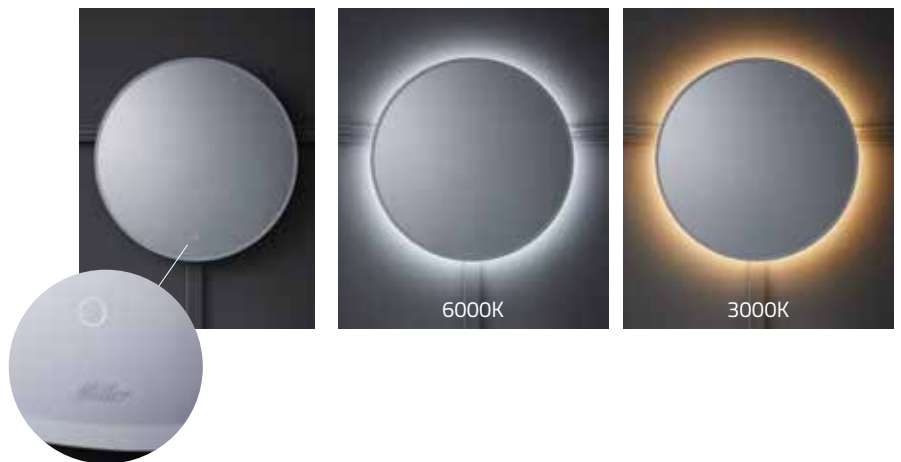

Detail: Touch-sensor and
15mm bevelled edge

PLAIN MIRROR GLASS

4 mm mirror glass. Grade polished edge. Suspension bracket for easy mounting and floating effect.

Read more about the Miller Way on www.millerbathrooms.co.uk



40, 60, 80, 100, 120 CM

Optional: dimmable LED Top Light



Code no.	Product	Measurement W x H x D mm	Price
59-G	Plain Mirror Glass 40	400 x 700 x 10	£49.95
60-G	Plain Mirror Glass 60	590 x 700 x 10	£69.95
61-G	Plain Mirror Glass 80	790 x 700 x 10	£89.95
62-G	Plain Mirror Glass 100	990 x 700 x 10	£99.95
63-G	Plain Mirror Glass 120	1180 x 700 x 10	£119.95
L102	LED top light	L355 x D133, light .16 x 16	£130

We recommend 2 x L102 for 120 Mirror 63-G Mirror.



Top Light L102:

Control the brightness with a touch sensor. Our new Bathroom Cabinet memorises the latest desired brightness when switched on and off. White neutral light, Led color 4000K, IP44.

Easily mounted directly on the mirror glass.

(The driver is built in and connects directly to 230V.)

ROUND MIRROR GLASS

4 mm mirror glass. Grade polished edge. Suspension bracket for easy mounting and floating effect.

Read more about the Miller Way on www.millerbathrooms.co.uk

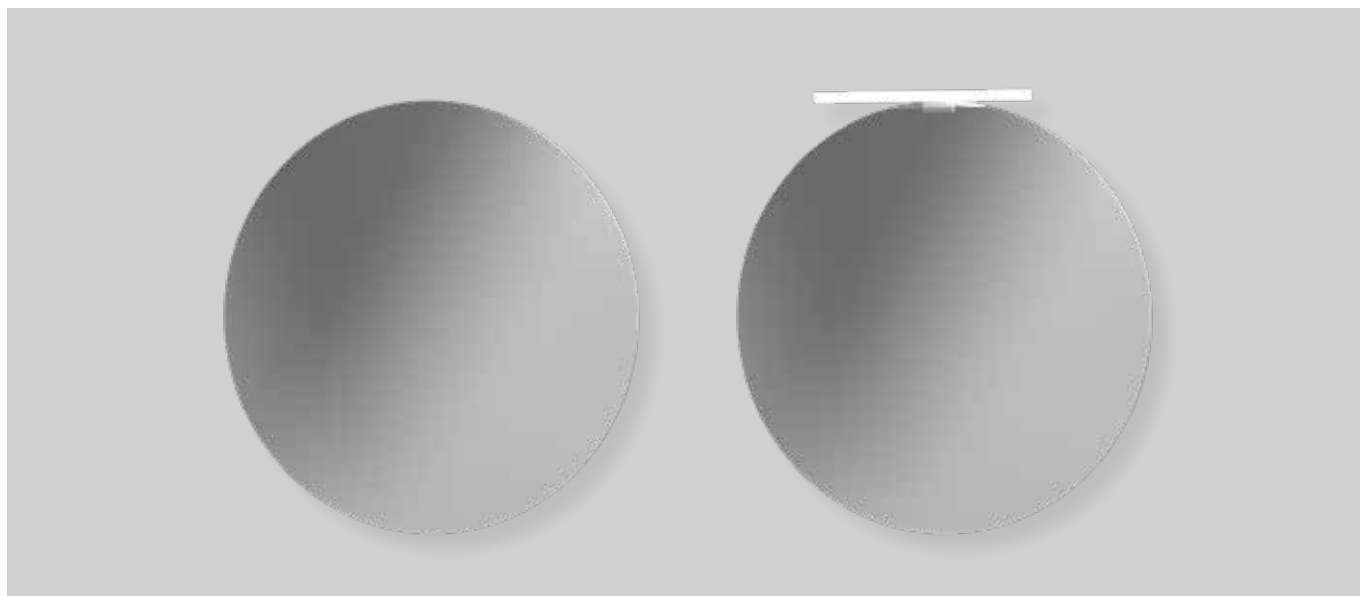

70, 90, 110 CM

Optional: dimmable LED Top Light



Code no.	Product	Measurement Ø x D mm	Price
R70-G	Round Mirror Glass 70	Ø70 x 10	£79.95
R90-G	Round Mirror Glass 90	Ø90 x 10	£129.95
R110-G	Round Mirror Glass 110	Ø110 x 10	£169.95
L102	LED top light	L355 x D133, light .16 x 16	£130



Top Light L102:

Control the brightness with a touch sensor. Our new Bathroom Cabinet memorises the latest desired brightness when switched on and off. White neutral light, Led color 4000K, IP44.

Easily mounted directly on the mirror glass.

(The driver is built in and connects directly to 230V.)

CLASSIC

Ceramic basins in 2 different designs

4 different widths

Matching floor standing or wall hung Toilet



Our timeless ceramic collection has been expanded and we have chosen to call this range, Classic. Basins with pedestals are now available in two designs, Classic Square and Classic Arch.

Classic Arch Basin and
Pedestal 332W-382W-1



Left to right: Floor Standing Toilet 388W-389W-C + Seat 347-4, Spare Roll Holder 5659CH, Toilet Roll Holder 5658CH, Basin with Pedestal 330W-321W-1, Mirror 643C, Basin with Pedestal 332W-382W-1, Mirror 641C, Toilet Brush Set 5638C, Wall Hung Toilet 390W + Seat 347-2



Classic Square



Classic Arch

CLASSIC CERAMIC

The series is crafted by hand in England, giving the products a higher density, meaning they are more impact resistant. The ceramic itself has a glossier, deeper and finer, almost glass-like surface.

Classic Arch basins have overflow holes in the shape of three lines. **Classic Square** basins have overflow holes in the shape of three small circles.

Read more about the Miller Way on www.millerbathrooms.co.uk

Ceramic Basins, Pedestals and Toilets



Basin set Classic Arch small
Including pedestal
White **331W-381W-1** £945



Classic Arch small basin
Basin without pedestal
White **381W-1** £589



Basin set Classic Arch large
Including pedestal
White **332W-382W-1** £1045



Classic Arch large basin
Basin without pedestal
White **382W-1** £689

Classic Arch basins can be wall hung.



Basin set Classic Square small
Including pedestal
White **330W-321W-1** £875



Basin set Classic Arch Square
Including pedestal
White **330W-322W-1** £985



Floor Standing Toilet Classic
Including cistern
White **332W-382W-1** £1299
Seat
White **347-2** £295
Black Oak **347-4** £595



Wall Hung Toilet Classic
Excl. tank and seat. (Suitable for built in tank like Geberit Duofix.)
White **390W** £695
Seat
White **347-2** £295
Black Oak **347-4** £595

Classic Square basins can not be wall hung.



Left hand door
White **353V-2** £700
Right hand door
White **353H-2** £700



Left hand door
White **354V-2** £700
Right hand door
White **354H-2** £700



With or without wooden back plate, IP23. Chrome finished with frosted white globe Ø150 mm. Polished Nickel.
With white back plate **301C-2** £225
Without back plate **301C** £199







Mirror with arched wooden frame and bevelled mirror glass. Fixed shelf with rail in chrome finish.
White **360C-2** £425

Cabinets - Arched frame with bevelled mirror glass alternatively panelled door in wood. 3 adjustable glass shelves. Bathroom cabinets are fitted with mounting rails and brackets for adjustable and quick installation.

Storage

Storage cabinets are available with plinth and adjustable feet or wall hung. Choose glass or wood panelled door. Storage cabinets are fitted with mounting rails and brackets for adjustable and quick installation. 1 fixed and 2 adjustable wood shelves. Wooden shelves have a decorative rounded front edge.

Storage cabinet floorstanding	Storage cabinet wall hung	Display cabinet floorstanding	Display cabinet wall hung
			
W439 x H1155 x D350 mm	W439 x H1125 x D350 mm	W439 x H1155 x D350 mm	W439 x H1125 x D350 mm
1 Panel Door Left hand door White 394V-2 £920 Right hand door White 394H-2 £920	1 Panel Door Left hand door White 1394V-2 £785 Right hand door White 1394H-2 £785	1 glass door with wood frame, tempered clear glass with bevelled edge Left hand door White 395V-2 £920 Right hand door White 395H-2 £920	1 glass door with wood frame, tempered clear glass with bevelled edge Left hand door White 1395V-2 £785 Right hand door White 1395H-2 £785



The floor standing toilet - now with an improved construction. Shown with Seat 347-2 in white acrylic. Soft close lid and quick release function.



Floor standing Toilet shown with Seat 347-4 in black stained solid oak. Soft close lid with decorative chrome fittings.



Classic tap

Delivered with pop up waste.
Chrome **19370C** £289

Basins are shown with tap 19370C in Chrome and classic style. Handles with ceramic details that read "hot" & "cold". Waste is included.



CERAMIC

All Edge and Bloc basins can be delivered in 4 colours. Glazed overflow holes. Matching bottom waste in ceramic is optional. Can be ordered without tap hole or three taphole with longer delivery time.























Soft close



Anti bacterial glaze

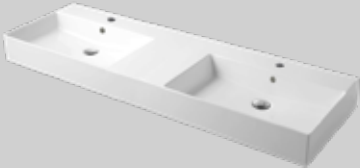

Easy to clean

<p>Edge 60 </p>  <p>110-60X46-01 Gloss white ceramic -01 £355 110-60X46-X Coloured ceramic -51, -54, -58 £465 W610 x H13 x D460 mm, max. depth bowl 120 mm</p>	<p>Edge 80 </p>  <p>110-80X46-01 Gloss white ceramic -01 £455 110-80X46-X Coloured ceramic -51, -54, -58 £595 W810 x H13 x D460 mm, max. depth bowl 120 mm</p>	<p>Edge 100 </p>  <p>110-100X46-01 Gloss white ceramic -01 £555 110-100X46-X Coloured ceramic -51, -54, -58 £755 W1010 x H13 x D460 mm, max. depth bowl 120 mm</p>
<p>Edge 120 </p>  <p>110-120X46-01 Gloss white ceramic -01 £755 110-120X46-X Coloured ceramic -51, -54, -58 £995 W1210 x H15 x D460 mm, max. depth bowl 122 mm</p>	<p>Edge 160 </p>  <p>110-160X46-01 Gloss white ceramic -01 £1255 110-160X46-X Coloured ceramic -51, -54, -58 £1755 W1610 x H15 x D460 mm, max. depth bowl 122 mm</p>	<p>Bloc 60 </p>  <p>111-60X46-01 Gloss white ceramic -01 £425 111-60X46-X Coloured ceramic -51, -54, -58 £575 W604 x H125 x D462 mm, max. depth bowl 120 mm</p>
<p>Bloc 80 </p>  <p>111-80X46-01 Gloss white ceramic -01 £525 111-80X46-X Coloured ceramic -51, -54, -58 £725 W804 x H125 x D462 mm, max. depth bowl 102 mm</p>	<p>Bloc 100 </p>  <p>111-100X46-01 Gloss white ceramic -01 £655 111-100X46-X Coloured ceramic -51, -54, -58 £895 W1004 x H125 x D462 mm, max. depth bowl 102 mm</p>	<p>Bloc 120 </p>  <p>111-120X46-01 Gloss white ceramic -01 £855 111-120X46-X Coloured ceramic -51, -54, -58 £1195 W1204 x H125 x D462 mm, max. depth bowl 102 mm</p>
<p>Bloc 160 </p>  <p>111-160X46-01 Gloss white ceramic -01 £1355 111-160X46-X Coloured ceramic -51, -54, -58 £1885 W1610 x H125 x D462 mm, max. depth bowl 102 mm</p>	<p>Edge Bowl</p>  <p><i>Basin 130-R40 is mounted on a worktop. It is only suitable with tap 1941 which is delivered with a fixed waste.</i></p> <p>130-R40-01 Gloss white ceramic -01 £340 130-R40-X Coloured ceramic -51, -54, -58 £465 Ø420 x H170 mm, max. depth bowl 150 mm</p>	<p>Edge Cylinder</p>  <p><i>Basin 131-R40 is mounted on a worktop. It is only suitable with tap 1941 which is delivered with a fixed waste.</i></p> <p>131-R40-01 Gloss white ceramic -01 £340 131-R40-X Coloured ceramic -51, -54, -58 £465 Ø400 x H165 mm, max. depth bowl 122 mm</p>

Bloc basins can be wall hung - For wall hanging of basins, we recommend using suitable brackets as support - not included. The basins are manufactured in genuine ceramic and therefore have a certain measurement tolerance. All measurements are for guidance only. Exact dimensions should be measured on each product you purchase before fitting. Technical drawings are available on www.millerbathrooms.co.uk.

Optional

No Taphole and Three Taphole basins

<p>Matching ceramic Waste</p> <p>110-190-01 Ceramic Waste - Gloss white ceramic £115 110-190-X Ceramic Waste - Coloured ceramic £135</p>		<p>Three taphole and No taphole solutions on all fullcover basins possible. No taphole solutions extended leadtime on request. Please contact nearest retailer for full details</p>	

Colour codes Edge, Bloc and Toilets

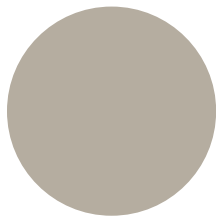

Coffee Cream -54

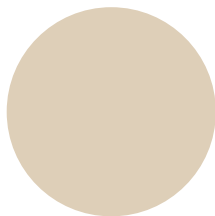

Cotton Cream -58

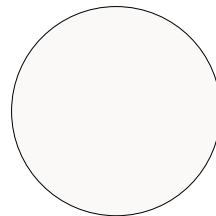

Matt White -51

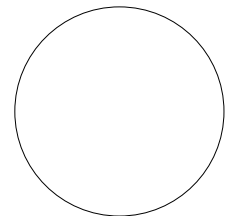



















Gloss White -01

<p>Wall Hung Toilet incl. Seat</p> <p><i>Rimless flush. Soft close, quick release plastic seat. Colour matched seat is included in the price.</i></p> <p>190-WCSET-01 Gloss white ceramic -01 £645 190-WCSET-X Coloured ceramic/seat -51, -54, -58 £895</p> <p>W375 x D500 mm</p> <p>Quick release</p>	<p>Floor Standing Toilet incl. Seat</p> <p><i>Rimless flush. Soft close, quick release plastic seat. Colour matched seat is included in the price.</i></p> <p>191-WCSET-01 Gloss white ceramic -01 £645 191-WCSET-X Coloured ceramic/seat -51, -54, -58 £895</p> <p>W375 x D500 x H405 mm</p> <p>Quick release</p>
---	---



CERAMIC

The basins are manufactured in genuine ceramic and therefore have a certain measurement tolerance. All measurements are for guidance only. Exact dimensions should be measured on each product you purchase before fitting. Technical drawings are available on www.millerbathrooms.co.uk.

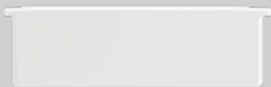
<p>Tap placed on the worktop, or inside wall</p>   <p>135W Ø330 x H125 mm, max. depth bowl 90 mm</p> <p>£300</p>		<p>Tap placed on the worktop, or inside wall</p>   <p>133W Ø395 x H150 mm, max. depth bowl 130 mm</p> <p>£315</p>	
<p>Tap placed on the worktop, or inside wall</p>   <p>150W Ø400/195 x H135 mm</p> <p>£330</p>		<p>Tap placed on the worktop, or inside wall</p>   <p>150W Ø400/195 x H135 mm</p> <p>£330</p>	
<p>174W1</p>   <p>174W1 Ø400x H150 x D415 mm</p> <p>£210</p>	<p>116W1</p>   <p>116W1 W500 x H180 x D495 mm</p> <p>£470</p>	<p>W405 x D355 mm</p>   <p>165W1 W405 x H50 x D355 mm</p> <p>£255</p>	
<p>171W1</p>   <p>171W1 Ø460 x H130 mm</p> <p>£299</p>	<p>173W1</p>   <p>173W1 W550 x H130 x D450 mm</p> <p>£299</p>	<p>P134W</p>   <p>P134W undermount basin £365 Note Exact dimensions are measured on delivered product before making work top cut outs. W490 x D320 mm. Max depth bowl 160 mm</p>	

TAPS AND WASTE

Taps are delivered without waste except tap: 1941C, 1941MP, 1941B which are delivered with a free flow waste - always open. 1937C, 1940C, 1940MP, 1940B, 1942C, 1943C, 1943B, 1943BN, are delivered with a pop-up waste. Technical drawings are available on millerbathrooms.co.uk. All taps are high pressure.



1943C
Chrome
"Click-clack" waste included
Close/open by pressing the lid

£295

1943B
Matt Black
"Click-clack" waste included
Close/open by pressing the lid

£295

1943BN
Stainless finish
"Click-clack" waste included
Close/open by pressing the lid

£395

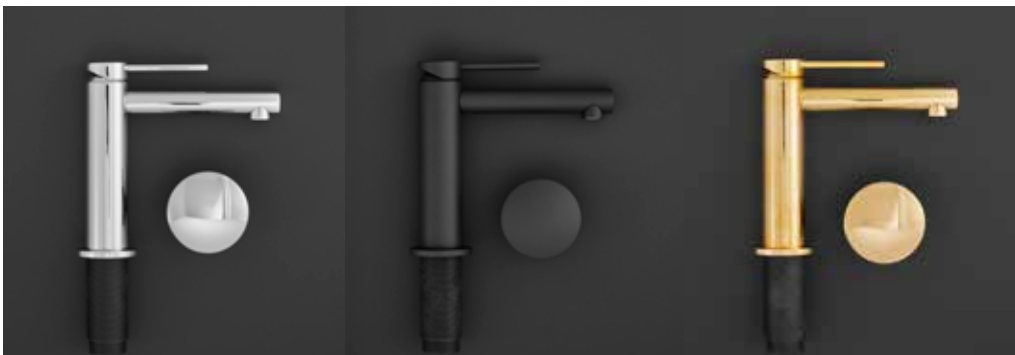
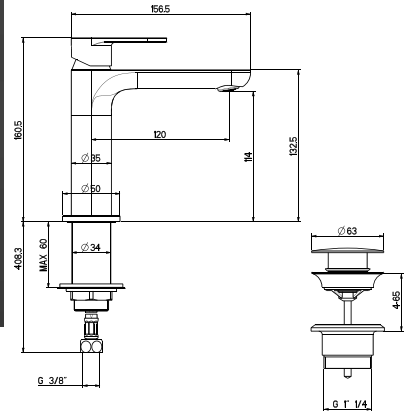

1940C
Chrome
"Click-clack" waste included
Close/open by pressing the lid

£295

1940B
Matt Black
"Click-clack" waste included
Close/open by pressing the lid

£395

1940MP
Polished untreated Brass
"Click-clack" waste included
Close/open by pressing the lid

£295

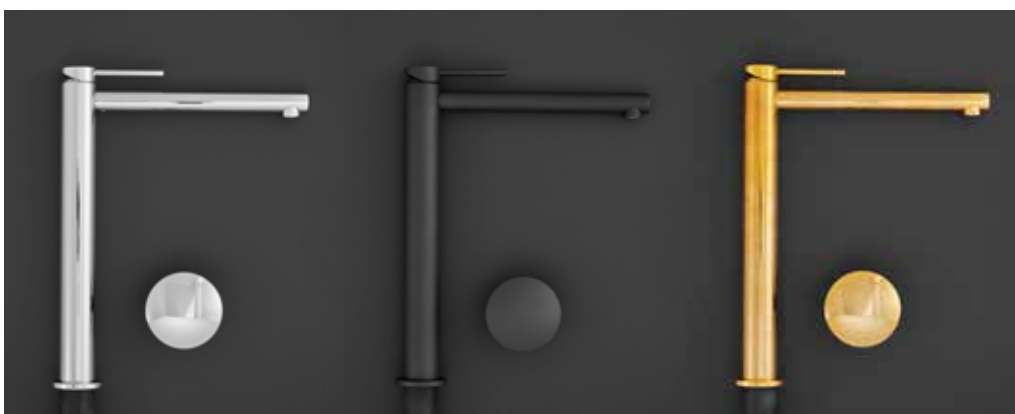
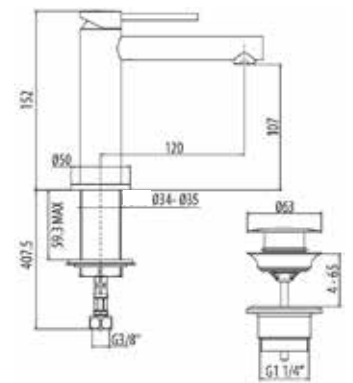

1941C
Chrome
Incl. free flow waste - always open

£395

1941B
Matt Black
Incl. free flow waste - always open

£595

1941MP
Polished untreated Brass
Incl. free flow waste - always open

£395

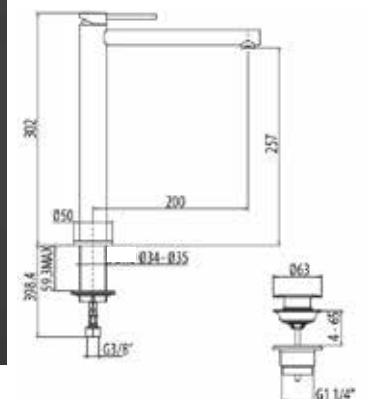

Free Flow waste means it is always open/cannot be closed.
This Free Flow waste is used for sinks that do not have an overflow hole.

Please see more taps on page 146

TAPS AND WASTE



1942C
Chrome
 "Click-clack" waste included
 Close/open by pressing the lid

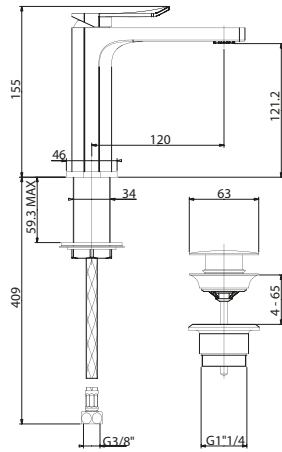

19370C
Chrome
 Delivered with pop up waste

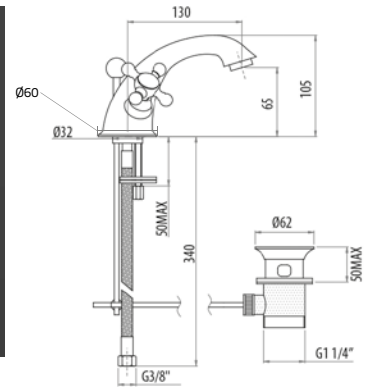

1935C
Chrome
 Best suitable for basin:
 174W1, 165W1, 166W1.
 Waste sold separately code 1968C

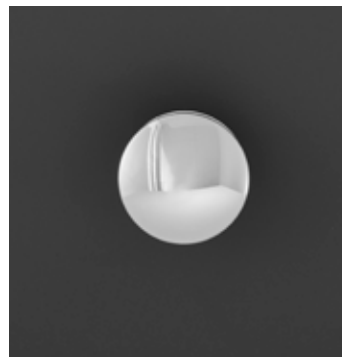
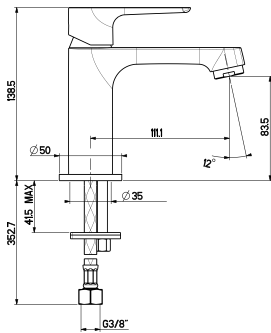

1968C "Pop-up" Waste Chrome £49
 Suits taps 1936C, 1935C
 Other mixers are delivered with a waste
 Close/open by pressing the cover cap

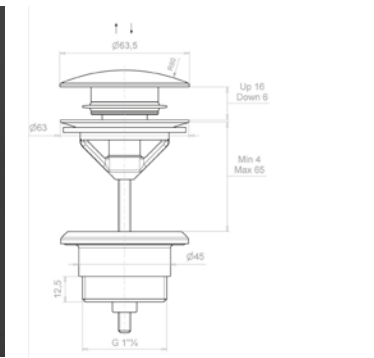

1936C
Chrome
 Waste sold separately code 1968C

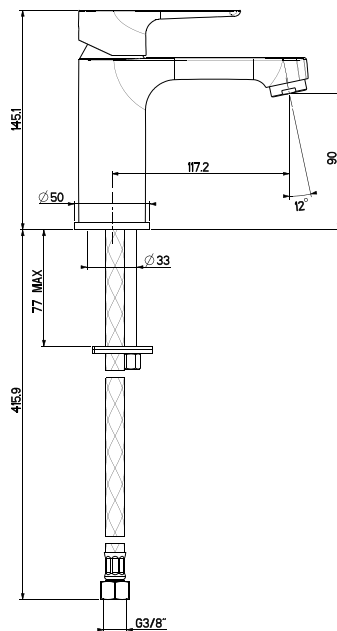

Miller

FINE BATHROOM INTERIORS



ARE YOU LOOKING FOR ASSEMBLY INSTRUCTIONS, MATERIAL FACTS AND CARE ADVICE

Please read more on
www.millerbathrooms.co.uk/material
www.millerbathrooms.co.uk/fixing

PRICES ETC

Prices listed in this brochure are approximate prices Sterling pounds including VAT, excluding shipping. Variations may occur. We reserve the right to adjust prices without notice.

GUARANTEE

Please read more on our website www.millerbathrooms.co.uk/guarantee

PHOTOGRAPHY

Richard Lindor, Patrik Svedberg, Nils Åstrand.

PROPS FOR PHOTOGRAPHY

Bovalls Dörrbyggeri, Byarums Bruk, Sonarps Interiör, Växbo Lin, Hide-a-Lite, Kilands Mattor, Karl Andersson och Söner, CC Höganäs, Severins Möbler, Swedese, Sofacompany.com, Numero74 Gardin Olsson och Västanehem.

The colour illustrations and measurements in this catalogue are for guidance only. Every care has been made to ensure that the product information is correct at time of printing. The company reserves the right to make alterations to the described designs, specifications, measurements and prices without prior notice or obligation. E&OE.

All illustrations and materials included in this catalogue are the copyright of Miller from Sweden Ltd. and cannot be used without prior written permission in any other publication, catalogue, brochure, advertisement or in any media what so ever, whether electronic or written including the internet. © 2024 Miller from Sweden Ltd.

HANDLES AND KNOBS

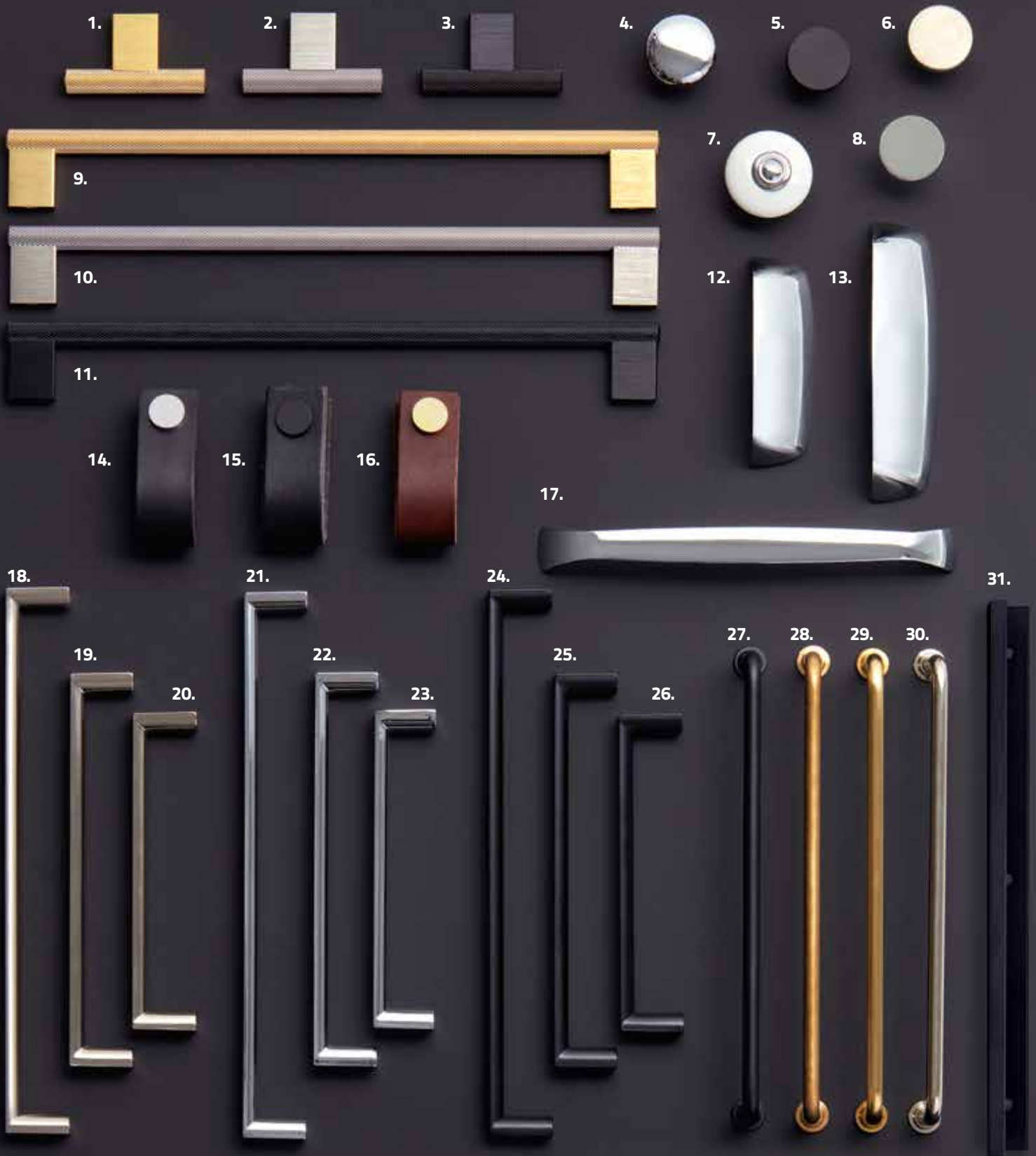

1. Knob	3102MP	Brass	L60, D10 mm	£14
2. Knob	3102BN	Stainless finish	L60, D10 mm	£14
3. Knob	3102B	Matt Black	L60, D10 mm	£14
4. Knob	3103C	Chrome	W30 mm	£10
5. Knob	3101B	Matt Black	Ø28, D25 mm	£10
6. Knob	3101BN	Stainless finish	Ø28, D25 mm	£10
7. Knob	3105C	Chrome/white	Ø36 mm	£15
8. Knob	3101C	Chrome	Ø28, D25 mm	£10
9. Handle	3002-256MP	Brass	c/c 256 mm	£24
10. Handle	3002-256BN	Stainless finish	c/c 256 mm	£24
11. Handle	3002-256B	Matt Black	c/c 256 mm	£24
12. Handle	3003-64C	Chrome	c/c 64 mm	£14
13. Handle	3003-96C	Chrome	c/c 96 mm	£14
14. Handle	3104C	Leather Black/Chrome	25x65 mm	£15
15. Handle	3104B	Leather Black/Black	25x65 mm	£15
16. Handle	3104MP	Leather Brown/Brass	25x65 mm	£15

17. Handle	3004-160C	Chrome	c/c 160 mm	£14
18. Handle	3001-224BN	Stainless finish	c/c 224 mm	£14
19. Handle	3001-160BN	Stainless finish	c/c 160 mm	£14
20. Handle	3001-128BN	Stainless finish	c/c 128 mm	£14
21. Handle	3001-224C	Chrome	c/c 224 mm	£14
22. Handle	3001-160C	Chrome	c/c 160 mm	£14
23. Handle	3001-128C	Chrome	c/c 128 mm	£14
24. Handle	3001-224B	Matt Black	c/c 224 mm	£14
25. Handle	3001-160B	Matt Black	c/c 160 mm	£14
26. Handle	3001-128B	Matt Black	c/c 128 mm	£14
27. Handle	3009-192B	Matt Black	c/c 192 mm	£15
28. Handle	3009-192MP	Untreated Brass	c/c 192 mm	£15
29. Handle	3009-192MP1	Brushed Brass	c/c 192 mm	£15
30. Handle	3009-192C	Chrome	c/c 192 mm	£15
31. Pull Handle	3006-192B	Matt Black	L 232 mm	£14

Miller
FINE BATHROOM INTERIORS

*Your way.
The Miller Way.*



MILLER FROM SWEDEN LTD.
Unit 16, Thame Park Business Centre
Wenman Road. Thame OX9 3XA, England
Tel: +44 (0) 1844 264800
sales@millerbathrooms.co.uk

www.millerbathrooms.co.uk